



CHNT

Empower the World

FİYAT LİSTESİ

MAYIS 2022

DÜNYADA CHNT

- 3 Dünya Çapında AR&GE Merkezi: Avrupa, Kuzey Amerika, Asya Pasifik
6 Uluslararası Pazarlama & Satış Alanı: Asya Pasifik, Orta Doğu ve Afrika, Avrupa, Latin Amerika, Kuzey Amerika, Çin
9 Üretim Tesisi: Çin (Wenzhou, Shanghai, Hangzhou, Xianyang, Jiuquan), Mısır, Almanya, Tayland
14 Uluslararası İştirak
17 Pazarlama Ofisi
22 Lojistik Merkezi
2300 Satış Şirketi



Ürünlerimizin sahip olduğu uluslararası sertifikalar:

TURKEY	EU	Netherland	Germany	Germany	Sweden	Finland	Czech	Indonesia	Ukraine	Russia	South Africa	USA	Canada	UK

CHINT - Akıllı Enerji Çözüm Ortağı



1984 yılında kurulan CHINT, 140'ın üzerinde ülkede ve bölgede, 30.000'den fazla çalışanıyla faaliyetlerini sürdürmektedir.

CHINT aktif olarak denizaşırı pazarlara açılmış, Avrupa, Kuzey Amerika ve Asya Pasifik'te 3 araştırma ve geliştirme (Ar-Ge) merkezi; Çin, Asya Pasifik, Avrupa, Batı Asya ve Afrika, Latin Amerika ve Kuzey Amerika'da 6 pazarlama ofisi; Almanya, Tayland, Malezya, Mısır, Singapur ve Vietnam'da da üretim üsleri kurmuştur. Küresel ticaretin sürekli ve istikrarlı bir şekilde büyümesini sağlamak amacıyla teknik ve ticari faaliyetlerini büyük bir titizlikle sürdürmektedir.

CHINT, küresel Ar-Ge sisteminin gelişimini aktif olarak teşvik ederek, 18 profesyonel teknoloji araştırma enstitüsü ve 3 denizaşırı Ar-Ge merkezlerine sahip

CHINT Group Araştırma Enstitüsü'nü kurmuş, endüstriyel gelişim ve inovasyon konseptine sadık kalmıştır. 4.000'den fazla patent lisansı almış ve 5.000 patent başvurusu yapmıştır. Ek olarak, 185 endüstriyel ve ulusal standardın oluşturulmasına öncülük etmiş; ulusal ve bölgesel boyutta olmak üzere 32 bilim ve teknoloji ödülü kazanmıştır.

CHINT, "elektrik enerjisini daha güvenli, çevreci, kullanışlı ve verimli hale getirmek" misyonu ile, insan odaklı ve değer paylaşımlı kültürüne bağlı kalmıştır. CHINT'in kurum imajını çevrecilik, enerji tasarrufu, sürdürülebilir inovasyon ve güvenilirlik anlayışı oluşturmaktadır. Kurum kültürünü müşteri odaklılık ve inovasyonun oluşturduğu CHINT, her yıl ortaya koyduğu çift haneli büyüme rakamları ile global düzeyde kendini geliştirmekte ve yenilemeye devam etmektedir.

Ana iş kolları



Temiz Enerji



Enerji Depolama



Enerji İletimi
ve Dağıtım



Enerji Tahsisi



Alçak Gerilim
Elektrik
Ekipmanları



Enerji Katma
Değerli Hizmetler



Akıllı Terminal



Büyük Veri



Yazılım
Geliştirme



Kontrol
Otomasyonu

	Otomatik Sigortalar 1-6
	eb Serisi Otomatik Sigortalar 1-2
	NXB ve NB7 Serisi Otomatik Sigortalar 3-4
	NB1 Serisi Otomatik Sigortalar 5
	DZ158 Serisi Otomatik Sigortalar 6
	NB1, NXB ve DZ158 Serileri Yardımcı Aksesuarlar 6
	Kaçak Akım Koruma Röleleri 7-9
	NL1 Serisi Kaçak Akım Koruma Röleleri RCCB 7-8
	NB1L Kaçak Akım Korumalı Otomatik Sigortalar - RCBO 9
	Alçak Gerilim Parafudrlar 10-11
	NU6 Alçak Gerilim Parafudrları 10
	Noark Ex9UE Alçak Gerilim Parafudrları 10-11
	Darbe Akım Anahtarları ve Modüler Kontaktörler 12-13
	NJMC1 Darbe Akım Anahtarları 12
	NCH8 Serisi Bina İçi Aydınlatma/Otomasyon Kontaktörü 13
	Zaman Saatleri 14
	NKG3 Dijital Zaman Saatleri 14
	KG316T Dijital Zaman Saatleri 14
	ATR-100 Analog Zaman Saatleri 14
	CHD Serisi Astronomik Zaman Rölesi 14
	Yük Ayırıcılar 15-16
	NH4 Din Ray Tıp Yük Ayırıcı 15
	NRT28-32 Kartuş ve Sigorta Yuvaları (gG/gL Hızlı Tıp Sigorta) 15
	NHR17 Serisi Yatay Yük Ayırıcıları 16
	NHRT40 Dikey Yük Ayırıcı 16
	NH40 Serisi Yük Ayırıcıları 16
	Otomatik Transfer Şalterleri 17
	NXZ Serisi Otomatik Transfer Şalterleri 17

Kompakt Tip Devre Kesiciler

19-24



NXM Serisi Kompakt Tip Devre Kesiciler	19
NXM Serisi Devre Kesiciler için Yardımcı Aksesuarlar	20
NM8 Alçak Gerilim Devre Kesiciler	21-22
NM8 Serisi Kompakt Tip Devre Kesiciler Aksesuarlar	23
NXMLE Serisi Kaçak Akım Algılamalı Kompakt Tip Devre Kesiciler	24
NM8L Kaçak Akım Korumalı Devre Kesiciler	24

Açık Tip Devre Kesiciler

26-27



NA1-X Serisi Açık Tip Devre Kesiciler ve Aksesuarları	26
NA8G Serisi Açık Tip Devre Kesiciler	27

Kaçak Akım Algılama Röleleri ve Akım Trafoları

28



RDC-01 & RDC-02 Serisi Kaçak Akım Algılama Rölesi ve Akım Trafoları	28
RDC-03 Serisi Kaçak Akım Algılama Rölesi ve Akım Trafoları	28

Alçak Gerilim Güç Kalitesi Ürünleri

29-31



AG Kuru Tip Kondansatörler	29
Şönt Reaktörler ve Endüktif Yük Sürücüler	30
CJ19 Serisi Kompanzasyon Kontaktörleri	31
Harmonik Filtre Reaktörleri	31

Motor Koruma ve Kontrol Ürünleri

33-43



NC1 Serisi Kontaktörler	33-35
NC1 Serisi Kontaktörler Aksesuarları	35
NXC Serisi Kontaktörler	36
NXC Serisi Yardımcı Aksesuarlar	36
NC2 Serisi Kontaktörler ve Aksesuarları	37
NC1 Uyumlu Termik Röleler	38
NXC Uyumlu Termik Röleler	39
NC2 Uyumlu Termik Röleler	39
NXC Serisi Mini Kontaktörler	40
NC6 Serisi Mini Kontaktörler	41
NS2 Serisi Motor Koruma Şalterleri ve Aksesuarları	42
NQ3 Serisi Kutulu Yolvericiler	43

	Endüstriyel Röle	44
	NJDC Endüstriyel Röle ve Soketleri	44
	Pano İklimlendirme Ekipmanları	44
	CN Serisi Pano İklimlendirme Ekipmanları	44
	Buton ve Sinyal Ürünleri	45-50
	EKO Serisi Ø22mm Plastik Seri Butonlar ve Sinyaller (LED)	45
	ND16 Plastik Seri Sinyal Lambası	46
	NP2 Serisi 22mm Metal Seri Buton ve Sinyal Lambası	47
	NP2 Serisi 22mm Plastik Seri Buton ve Sinyal Lambası	48
	NP8 Serisi 22mm Krom Gövde Seri Buton ve Sinyal Lambası	49
	NP2 Kutular	50
	MRT11 Serisi Modüler Röleler	51-52
	Zaman Röleleri	51
	Gerilim Koruma Röleleri	51
	Motor (Faz) Koruma Röleleri	51
	Hidrofor Sıralama Rölesi	52
	Fotosel Rölesi	52
	Sıvı Seviye Kontrol Röleleri	52
	Ölçüm Cihazları	53
	CDM Serisi Dijital Multimetreler	53
	CDM-04 Serisi Enerji Analizörü	53
	CDM-03 Serisi Enerji Güç Ölçer	53
	Dijital Voltmetre ve Ampermetreler	53
	Pako Şalterler	54-61
	CSL Serisi Pako Şalterler	54-57
	CSX Serisi Pako Şalterler	58-61

ÖNEMLİ NOTLAR:





- Fiyatlarımıza her an ihbara gerek duymaksızın değişiklik yapma hakkımız saklıdır.
- Teslim tarihindeki liste fiyatlarımız faturalamaya esastır.
- Fiyatlarımıza KDV dahil değildir.

- Listemiz dışındaki ürünler için tarafımızla temasa geçiniz.
- Resimler ve teknik veriler sadece bilgi amaçlıdır.
- Uygulamalarınızda kullanım kılavuzlarına riayet ediniz.

eB Serisi Otomatik Sigortalar

4.5 kA B | Hızlı Karakterli



	In (A) 230/400 V AC 50/60 Hz	Sipariş Kodu	Birim Fiyat (€)	Kutu Adeti
1 Kutup 	1	186423	3,51	12
	2	186424	3,04	12
	3	186425	3,51	12
	4	186426	3,51	12
	6	186428	2,91	12
	10	186429	2,75	12
	16	186430	2,75	12
	20	186431	2,75	12
	25	186432	2,75	12
	32	186433	3,28	12
	40	186434	3,61	12
	50	186577	4,10	12
	63	186997	4,42	12
2 Kutup 	1	186447	7,55	6
	2	186448	7,55	6
	3	186449	7,55	6
	4	186450	7,86	6
	6	186452	7,55	6
	10	186453	6,77	6
	16	186454	6,77	6
	20	186455	6,77	6
	25	186456	6,77	6
	32	186457	7,62	6
	40	186458	8,10	6
	50	186571	8,44	6
	63	187002	8,61	6
3 Kutup 	1	186507	12,13	4
	2	186508	12,13	4
	3	186509	12,13	4
	4	186510	12,13	4
	6	186512	12,13	4
	10	186513	10,33	4
	16	186514	10,33	4
	20	186515	10,33	4
	25	186516	10,33	4
	32	186517	11,32	4
	40	186518	11,65	4
	50	186562	13,67	4
	63	186996	15,19	4
4 Kutup 	1	186519	15,58	3
	2	186520	15,58	3
	3	186521	15,58	3
	4	186522	15,58	3
	6	186524	15,58	3
	10	186525	13,44	3
	16	186526	13,44	3
	20	186527	13,44	3
	25	186528	13,44	3
	32	186529	14,40	3
	40	186530	16,71	3
	50	186559	18,06	3
	63	187003	20,39	3

*Otomatik sigortalar kutu bazlı sipariş alınır ve sevk edilir.







eB Serisi Otomatik Sigortalar

4.5 kA C | Yavaş Karakterli



IEC IEC/EN60898-1

	In (A) 230/400 V AC 50/60 Hz	Sipariş Kodu	Birim Fiyat (€)	Kutu Adeti
1 Kutup 	1	186411	3,12	12
	2	186412	3,12	12
	3	186413	3,12	12
	4	186414	3,12	12
	6	186416	3,11	12
	10	186417	2,75	12
	16	186418	2,75	12
	20	186419	2,75	12
	25	186420	2,75	12
	32	186421	3,28	12
	40	186422	3,61	12
	50	186576	4,10	12
	63	185639	4,35	12
	2 Kutup 	1	186459	8,57
2		186460	8,40	6
3		186461	8,40	6
4		186462	8,40	6
6		186464	7,29	6
10		186465	7,10	6
16		186466	7,10	6
20		186467	7,10	6
25		186468	7,10	6
32		186469	7,73	6
40		186470	8,23	6
50		186570	8,63	6
63		185640	9,65	6
3 Kutup 		1	186495	13,12
	2	186496	13,12	4
	3	186497	13,12	4
	4	186498	13,12	4
	6	186500	10,83	4
	10	186501	10,08	4
	16	186502	10,08	4
	20	186503	10,08	4
	25	186504	10,08	4
	32	186505	11,15	4
	40	186506	11,71	4
	50	186561	13,24	4
	63	185641	14,85	4
	4 Kutup 	1	186531	15,94
2		186532	15,94	3
3		186533	15,94	3
4		186534	15,94	3
6		186536	14,61	3
10		186537	14,05	3
16		186538	14,05	3
20		186539	14,05	3
25		186540	14,05	3
32		186541	15,10	3
40		186542	16,73	3
50		186557	18,06	3
63		186804	20,39	3









*Otomatik sigortalar kutu bazlı sipariş alınır ve sevk edilir.



6 kA Otomatik Sigortalar

IEC IEC/EN60898-1

B | Hızlı Karakterli

NXB	In (A) 230/400 V AC 50/60 Hz	NXB		NB7		Kutu Adeti	NB7
		Sipariş Kodu	Birim Fiyat (€)	Sipariş Kodu	Birim Fiyat (€)		
1 Kutup 	1	814034	4,16	192160	4,26	12	1 Kutup 
	2	814035	4,16	192161	4,26	12	
	3	814036	4,16	192162	4,26	12	
	4	814037	4,16	192163	4,26	12	
	6	814038	3,67	192164	3,75	12	
	10	814039	3,03	192165	3,11	12	
	16	814040	3,03	192166	3,11	12	
	20	814041	3,03	192167	3,11	12	
	25	814042	3,03	192168	3,11	12	
	32	814043	3,59	192169	3,67	12	
	40	814044	3,97	192170	4,07	12	
	50	814045	4,46			12	
	63	814046	4,61			12	
2 Kutup 	1	814112	9,18	192199	9,38	6	2 Kutup 
	2	814113	9,18	192200	9,38	6	
	3	814114	9,18	192201	9,38	6	
	4	814115	9,18	192202	9,38	6	
	6	814116	8,33	192203	8,53	6	
	10	814117	7,65	192204	7,82	6	
	16	814118	7,65	192205	7,82	6	
	20	814119	7,65	192206	7,82	6	
	25	814120	7,80	192207	7,98	6	
	32	814121	8,86	192208	9,08	6	
	40	814122	9,18	192209	9,38	6	
	50	814123	10,08			6	
	63	814124	10,39			6	
3 Kutup 	1	814190	13,31	192238	13,61	4	3 Kutup 
	2	814191	13,31	192239	13,61	4	
	3	814192	13,31	192240	13,61	4	
	4	814193	13,31	192241	13,61	4	
	6	814194	12,78	192242	13,08	4	
	10	814195	11,01	192243	11,26	4	
	16	814196	11,01	192244	11,26	4	
	20	814197	11,01	192245	11,26	4	
	25	814198	11,16	192246	11,42	4	
	32	814199	12,83	192247	13,16	4	
	40	814200	15,55	192248	15,92	4	
	50	814201	16,59			4	
	63	814202	18,03			4	
4 Kutup 	1	814268	18,36	192277	18,78	3	4 Kutup 
	2	814269	18,36	192278	18,78	3	
	3	814270	18,36	192279	18,78	3	
	4	814271	18,36	192280	18,78	3	
	6	814272	17,11	192281	17,52	3	
	10	814273	15,29	192282	15,66	3	
	16	814274	15,29	192283	15,66	3	
	20	814275	15,29	192284	15,66	3	
	25	814276	15,29	192285	15,66	3	
	32	814277	17,59	192286	18,01	3	
	40	814278	18,36	192287	18,78	3	
	50	814279	19,77			3	
	63	814280	21,63			3	

*Otomatik sigortalar kutu bazlı sipariş alınır ve sevk edilir.



6 kA Otomatik Sigortalar

IEC IEC/EN60898-1

C | Yavaş Karakterli

NXB	In (A) 230/400 V AC 50/60 Hz	NXB		NB7		Kutu Adeti	NB7
		Sipariş Kodu	Birim Fiyat (€)	Sipariş Kodu	Birim Fiyat (€)		
1 Kutup	1	814008	4,21	192173	4,30	12	1 Kutup
	2	814009	4,21	192174	4,30	12	
	3	814010	4,21	192175	4,30	12	
	4	814011	4,21	192176	4,30	12	
	6	814012	3,59	192177	3,68	12	
	10	814013	3,06	192178	3,13	12	
	16	814014	3,06	192179	3,13	12	
	20	814015	3,06	192180	3,13	12	
	25	814016	3,06	192181	3,13	12	
	32	814017	3,62	192182	3,71	12	
	40	814018	4,48	192183	4,58	12	
	50	814019	6,07	179624	6,21	12	
	63	814020	6,39	179626	6,55	12	
	2 Kutup	1	814086	11,14	192212	11,41	
2		814087	11,14	192213	11,41	6	
3		814088	11,14	192214	11,41	6	
4		814089	11,14	192215	11,41	6	
6		814090	9,90	192216	10,13	6	
10		814091	9,90	192217	10,13	6	
16		814092	9,90	192218	10,13	6	
20		814093	9,90	192219	10,13	6	
25		814094	9,90	192220	10,13	6	
32		814095	10,53	192221	10,77	6	
40		814096	11,14	192222	11,41	6	
50		814097	17,69	179666	18,10	6	
63		814098	19,40	179668	19,88	6	
3 Kutup		1	814164	15,55	192251	15,93	4
	2	814165	15,55	192252	15,93	4	
	3	814166	15,55	192253	15,93	4	
	4	814167	15,55	192254	15,93	4	
	6	814168	12,78	192255	13,08	4	
	10	814169	12,78	192256	13,08	4	
	16	814170	12,78	192257	13,08	4	
	20	814171	12,78	192258	13,08	4	
	25	814172	12,78	192259	13,08	4	
	32	814173	14,67	192260	15,00	4	
	40	814174	16,01	192261	16,39	4	
	50	814175	20,98	179708	21,47	4	
	63	814176	26,03	179710	26,68	4	
	4 Kutup	1	814242	23,15	192290	23,68	3
2		814243	23,15	192291	23,68	3	
3		814244	23,15	192292	23,68	3	
4		814245	23,15	192293	23,68	3	
6		814246	19,38	192294	19,85	3	
10		814247	18,53	192295	18,98	3	
16		814248	18,53	192296	18,98	3	
20		814249	18,53	192297	18,98	3	
25		814250	18,53	192298	18,98	3	
32		814251	19,96	192299	20,44	3	
40		814252	22,61	192300	23,14	3	
50		814253	32,16	179750	32,91	3	
63		814254	34,40	179752	35,28	3	

*NB7 grubunda 50A ve 63A ürünler NB1 serisi olarak sevk edilmektedir.





*Otomatik sigortalar kutu bazlı sipariş alınır ve sevk edilir.



NB1 Serisi Otomatik Sigortalar

10 kA C | Yavaş Karakterli

IEC IEC/EN60898-1



	In (A) 230/400 V AC 50/60 Hz	Sipariş Kodu	Birim Fiyat (€)	Kutu Adeti
1 Kutup 	1	179781	7,61	12
	2	179785	7,61	12
	3	179788	7,61	12
	4	179790	7,61	12
	6	179793	6,29	12
	10	179782	5,96	12
	16	179784	5,96	12
	20	179786	5,96	12
	25	179787	5,96	12
	32	179789	6,09	12
	40	179791	6,98	12
	50	179792	7,64	12
	63	179794	8,64	12
	2 Kutup 	1	179823	17,83
2		179827	17,83	6
3		179830	17,83	6
4		179832	17,83	6
6		179835	17,98	6
10		179824	15,50	6
16		179826	15,50	6
20		179828	15,50	6
25		179829	15,50	6
32		179831	17,98	6
40		179833	18,60	6
50		179834	21,05	6
63		179836	23,54	6
3 Kutup 		1	179865	26,49
	2	179869	26,49	4
	3	179872	26,49	4
	4	179874	26,49	4
	6	179877	20,80	4
	10	179866	19,31	4
	16	179868	19,31	4
	20	179870	19,31	4
	25	179871	20,49	4
	32	179873	21,36	4
	40	179875	22,71	4
	50	179876	24,86	4
	63	179878	29,43	4
	4 Kutup 	1	179907	34,75
2		179911	34,75	3
3		179914	34,75	3
4		179916	34,75	3
6		179919	28,08	3
10		179908	26,74	3
16		179910	26,74	3
20		179912	26,74	3
25		179913	26,74	3
32		179915	27,04	3
40		179917	28,69	3
50		179918	39,71	3
63		179920	44,57	3

*Otomatik sigortalar kutu bazlı sipariş alınır ve sevk edilir.

DZ158 Serisi Otomatik Sigortalar

IEC IEC/EN60947-2

10 kA | Yavaş Karakterli

	In (A) 230/400 V AC 50/60 Hz	Sipariş Kodu	Birim Fiyat (€)	Kutu Adeti
1 Kutup 	63	158088	16,93	12
	80	158089	17,66	12
	100	158087	19,65	12
	125	158107	31,61	12
3 Kutup 	63	158094	37,50	4
	80	158095	55,79	4
	100	158093	58,91	4
	125	158109	64,90	4
4 Kutup 	63	158097	74,81	3
	80	158098	76,55	3
	100	158096	79,12	3
	125	158110	108,44	3

NXB Serisi Aksesuarlar

	Ürün Tanımı	Sipariş Kodu	Birim Fiyat (€)	Kutu Adeti
İlave Bloklar 	NXB AX-X1 Yardımcı kontak	814991	8,65	14
	NXB AL-X1 Alarm kontak	814990	8,65	14
	NXB SHT-X1 Açtırma bobini 24V/48V AC/DC	814988	12,63	9
	NXB SHT-X1 Açtırma bobini 230V/400V AC	814989	12,63	9
	NXB UVT Düşük gerilim bobini	814987	18,70	9

NB1 Serisi Aksesuarlar

	Ürün Tanımı	Sipariş Kodu	Birim Fiyat (€)	Kutu Adeti
İlave Bloklar 	S9 açtırma Bobini 220/380 V	184986	19,54	9
	S9 açtırma Bobini 24 V AC/DC	184985	19,54	9
	S9 açtırma Bobini 48 V AC/DC	184984	19,54	9
	V9 Düşük gerilim Bobini 220/380 V	184988	28,90	9
	F9 Yardımcı Kontak Bloğu 3A 1NA+1NK	184994	14,53	14
	F9J Alarm Konağı 3A, 1NA+1NK	184996	14,53	14

DZ Serisi Aksesuarlar

	Ürün Tanımı 230/400 V AC 50/60 Hz	Sipariş Kodu	Birim Fiyat (€)	Kutu Adeti
	AX-1 yardımcı Kontak Bloğu 3A, 1NA+1NK	158999	13,14	12



*Otomatik sigortalar kutu bazlı sipariş alınır ve sevk edilir.

NL1 Serisi Kaçak Akım Röleleri

AC ve A Tipi | DIN Ray Tipi

IEC IEC/EN61008-1

AC Tipi (6kA)

Anlık ya da yavaşça artan AC kaçak akıma karşı gecikmesiz açma yapar.



	230/400 V AC 50/60 Hz	In (A)	Sipariş Kodu	Birim Fiyat (€)
2 kutup	30mA	25 A	200212	21,82
		40 A	200213	21,89
		63 A	200214	25,01
		80 A	200277	33,93
		100A	200278	40,88
	300mA	25 A	200218	21,69
		40 A	200219	21,69
		63 A	200220	24,83
		80 A	200281	33,33
		100A	200282	37,42
4 kutup	30mA	25 A	200223	31,40
		40 A	200224	31,71
		63 A	200225	34,83
	300mA	25 A	200229	29,84
		40 A	200230	30,61
		63 A	200231	32,57
		80 A	200760	48,45
		100A	200758	54,51

A Tipi (10kA)

Anlık ya da yavaşça artan AC ve DC kaçak akımlarına karşı gecikmesiz açma yapar.



	230/400 V AC 50/60 Hz	In (A)	Sipariş Kodu	Birim Fiyat (€)
2 kutup	30mA	25A	200584	32,64
		40A	200362	32,81
		63A	200363	34,66
	300mA	25A	200585	31,90
		40A	200586	32,12
		63A	200587	34,10
4 kutup	30mA	25A	200368	41,85
		40A	200364	44,51
		63A	200365	50,98
	300mA	25A	200372	40,70
		40A	200366	42,90
		63A	200367	49,50

AC-G Tipi (10kA)

IEC IEC/EN61008-1

Yavaşça artan AC kaçak akıma karşı, arıza noktasına en yakın konumdaki kaçak akım koruma rölesinin açmasını mümkün kılacak şekilde 10ms gecikmeli açma yapar.



	230/400 V AC 50/60 Hz	In (A)	Sipariş Kodu	Birim Fiyat (€)
2 kutup	30mA	40A	200572	33,99
		63A	200575	35,03
	300mA	40A	200574	33,99
		63A	200577	33,99
4 kutup	30mA	40A	200578	60,36
		63A	200581	62,09
	300mA	40A	200580	46,49
		63A	200583	56,19



A-G Tipi (10kA)

AC ve DC kaçak akımlara karşı, önce arıza noktasına en yakın konumdaki kaçak akım koruma rölesinin açmasını mümkün kılacak şekilde gecikmeli açma yapar.



	230/400 V AC 50/60 Hz	In (A)	Sipariş Kodu	Birim Fiyat (€)
2 kutup	30mA	40A	200560	37,40
		63A	200563	38,50
	300mA	40A	200562	37,92
		63A	200565	38,71
4 kutup	30mA	40A	200566	67,32
		63A	200569	72,46
	300mA	40A	200568	50,66
		63A	200571	58,22



SI- A Tipi (6kA)

AC kaçak akım ve DC puls kaçak akımlara karşı koruma özelliği vardır. Harmonikler ve transiyent kaynaklı akım piklerinde açmaya karşı korumalıdır.



	230/400 V AC 50/60 Hz	In (A)	Sipariş Kodu	Birim Fiyat (€)
2 kutup	30mA	25A	200629	38,75
		40A	200628	40,72
		63A	200627	51,96
	300mA	25A	200623	49,99
		40A	200622	53,64
		63A	200621	64,89
4 Kutup	30mA	25A	200638	53,64
		40A	200637	55,60
		63A	200636	70,51
	300mA	25A	200632	72,49
		40A	200631	72,49
		63A	200630	91,03





NB1L Kaçak Akım Korumalı Otomatik Sigortalar (6kA C)

Elektronik | DIN ray tipi

DNV IEC IEC/EN60898-1

Kaçak akım korumalı otomatik sigortalar, kaçak akım rölesi ve termik manyetik devre kesiciden oluşan ürünlerdir.

	In (A)	Sipariş Kodu	Birim Fiyat (€)
2 Kutup 30 mA 	6	197967	32,81
	10	197931	32,81
	16	197935	32,81
	20	197943	32,81
	25	197947	32,81
	32	197955	32,81
	40	197963	34,38
4 Kutup 300mA 	10	198105	65,50
	16	198109	65,50
	20	198117	65,50
	25	198121	65,50
	32	198129	67,51
	40	198137	74,85
NB1L-40H Serisi 4 Kutup 40 A 10kA A Tipi Kaçak Akımlı DC Pulse Kesme		198315	63,82



NU6 Alçak Gerilim Parafudrları

IEC IEC/EN NOARK

NU6-IIG/F Serisi

Tip 1 (Sayaç öncesi, ana dağıtım panosu)

Ürün Tanımı	Tip	Kutup Sayısı	Sürekli Çalışma Gerilimi Uc (V)	Imax (kA)	Up (kV)	Sipariş Kodu	Birim Fiyat (€)
NU6-IIG/F T1 100kA 385V 3P+N	Tip 1	3 Kutup + Nötr	385	100	2,5	252564	389,27

Tip 2 (Sayaç sonrası, tali pano)

Ürün Tanımı	Tip	Kutup Sayısı	Sürekli Çalışma Gerilimi Uc (V)	Imax (kA)	Up (kV)	Sipariş Kodu	Birim Fiyat (€)
NU6-IIG/F T2 20kA 320V 1P	Tip 2	1 Kutup	275	40	1,5	252499	24,52
NU6-IIG/F T2 20kA 320V 1P+N	Tip 2	1 Kutup + Nötr	275	40	1,5	252515	52,64
NU6-IIG/F T2 20kA 320V 3P	Tip 2	3 Kutup	275	40	1,5	252547	72,10
NU6-IIG/F T2 20kA 320V 3P+N	Tip 2	3 Kutup + Nötr	275	40	1,5	252563	111,74



Noark Ex9UE Alçak Gerilim Parafudrları

Tip 1 + 2 (Sayaç öncesi, ana dağıtım panosu)

Ürün Tanımı	Tip	Kutup Sayısı	Sürekli Çalışma Gerilimi Uc (V)	Imax (kA)	Sipariş Kodu	Birim Fiyat (€)
Ex9UE1+2 12.5 275	Tip 1+2	1 Kutup	275	50	103332	65,27
Ex9UE1+2 12.5R 275	Tip 1+2	1 Kutup	275	50	103333	67,15
Ex9UE1+2 12.5 275	Tip 1+2	1 Kutup+Nötr	275	50	103334	127,31
Ex9UE1+2 12.5R 275	Tip 1+2	1 Kutup+Nötr	275	50	103335	132,68
Ex9UE1+2 12.5 275	Tip 1+2	2 Kutup	275	50	103336	132,68
Ex9UE1+2 12.5R 275	Tip 1+2	2 Kutup	275	50	103337	139,80
Ex9UE1+2 12.5 275	Tip 1+2	3 Kutup	275	50	103338	185,81
Ex9UE1+2 12.5R 275	Tip 1+2	3 Kutup	275	50	103339	199,84
Ex9UE1+2 12.5 275	Tip 1+2	3 Kutup+Nötr	275	50	103340	254,74
Ex9UE1+2 12.5R 275	Tip 1+2	3 Kutup+Nötr	275	50	103341	268,97
Ex9UE1+2 12.5 275	Tip 1+2	4 Kutup	275	50	103342	268,97
Ex9UE1+2 12.5R 275	Tip 1+2	4 Kutup	275	50	103343	291,88



Aksesuar

Ürün Tanımı	Sürekli Çalışma Gerilimi Uc (V)	Sipariş Kodu	Birim Fiyat (€)
Ex9UE1+2 12.5 1P 275 M	275	103330	48,40
Ex9UE1+2 NPE M	N-PE	103331	48,40



* Ürün tanımında "R" ibaresi bulunan ürünlerde bir üstündeki üründen farklı olarak sinyal kontağı bulunmaktadır.



Noark Ex9UE Alçak Gerilim Parafudrları

IEC IEC/EN NOARK

Parafudr Tip 2 (Sayaç sonrası, tali pano)



Ürün Tanımı	Tip	Kutup Sayısı	Sürekli Çalışma Gerilimi Uc (V)	Imax (kA)	Sipariş Kodu	Birim Fiyat (€)
Ex9UE2 20 275	Tip 2	1 Kutup	275	40	103347	29,96
Ex9UE2 20R 275	Tip 2	1 Kutup	275	40	103348	35,32
Ex9UE2 20 275	Tip 2	1 Kutup+Nötr	275	40	103349	65,27
Ex9UE2 20R 275	Tip 2	1 Kutup+Nötr	275	40	103350	70,61
Ex9UE2 20 275	Tip 2	2 Kutup	275	40	103351	65,27
Ex9UE2 20R 275	Tip 2	2 Kutup	275	40	103352	70,61
Ex9UE2 20 275	Tip 2	3 Kutup	275	40	103353	100,87
Ex9UE2 20R 275	Tip 2	3 Kutup	275	40	103354	106,27
Ex9UE2 20 275	Tip 2	3 Kutup+Nötr	275	40	103355	129,17
Ex9UE2 20R 275	Tip 2	3 Kutup+Nötr	275	40	103356	141,54
Ex9UE2 20 275	Tip 2	4 Kutup	275	40	103357	139,80
Ex9UE2 20R 275	Tip 2	4 Kutup	275	40	103358	153,73
Ex9UE2 20 320	Tip 2	1 Kutup	320	40	103754	36,27
Ex9UE2 20R 320	Tip 2	1 Kutup	320	40	103755	38,47
Ex9UE2 20 320	Tip 2	1 Kutup+Nötr	320	40	103756	75,35
Ex9UE2 20R 320	Tip 2	1 Kutup+Nötr	320	40	103757	81,03
Ex9UE2 20 320	Tip 2	2 Kutup	320	40	103758	75,35
Ex9UE2 20R 320	Tip 2	2 Kutup	320	40	103759	81,03
Ex9UE2 20 320	Tip 2	3 Kutup	320	40	103760	112,57
Ex9UE2 20R 320	Tip 2	3 Kutup	320	40	103761	129,69
Ex9UE2 20 320	Tip 2	3 Kutup+Nötr	320	40	103762	153,73
Ex9UE2 20R 320	Tip 2	3 Kutup+Nötr	320	40	103763	167,65
Ex9UE2 20 20	Tip 2	4 Kutup	320	40	103764	153,73
Ex9UE2 20R 320	Tip 2	4 Kutup	320	40	103765	167,65
Ex9UE2 20 385	Tip 2	1 Kutup	385	40	103766	43,20
Ex9UE2 20R 385	Tip 2	1 Kutup	385	40	103767	44,77
Ex9UE2 20 385	Tip 2	1 Kutup+Nötr	385	40	103768	91,42
Ex9UE2 20R 385	Tip 2	1 Kutup+Nötr	385	40	103769	101,81
Ex9UE2 20 385	Tip 2	2 Kutup	385	40	103770	91,42
Ex9UE2 20R 385	Tip 2	2 Kutup	385	40	103771	101,81
Ex9UE2 20 385	Tip 2	3 Kutup	385	40	103772	133,09
Ex9UE2 20R 385	Tip 2	3 Kutup	385	40	103773	143,83
Ex9UE2 20 385	Tip 2	3 Kutup+Nötr	385	40	103774	167,65
Ex9UE2 20R 385	Tip 2	3 Kutup+Nötr	385	40	103775	178,08
Ex9UE2 20 385	Tip 2	4 Kutup	385	40	103776	167,65
Ex9UE2 20R 385	Tip 2	4 Kutup	385	40	103777	178,08
Ex9UE2 20 440	Tip 2	1 Kutup	440	40	103359	43,20
Ex9UE2 20R 440	Tip 2	1 Kutup	440	40	103360	44,77
Ex9UE2 20 440	Tip 2	1 Kutup+Nötr	440	40	103361	91,42
Ex9UE2 20R 440	Tip 2	1 Kutup+Nötr	440	40	103362	101,81
Ex9UE2 20 440	Tip 2	2 Kutup	440	40	103363	91,42
Ex9UE2 20R 440	Tip 2	2 Kutup	440	40	103364	101,81
Ex9UE2 20 440	Tip 2	2 Kutup	440	40	103365	133,09
Ex9UE2 20R 440	Tip 2	3 Kutup	440	40	103366	143,83
Ex9UE2 20 440	Tip 2	3 Kutup+Nötr	440	40	103367	167,65
Ex9UE2 20R 440	Tip 2	3 Kutup+Nötr	440	40	103368	178,08
Ex9UE2 20 440	Tip 2	4 Kutup	440	40	103369	167,65
Ex9UE2 20R 440	Tip 2	4 Kutup	440	40	103370	178,08



Ürün Tanımı	Sürekli Çalışma Gerilimi Uc (V)	Sipariş Kodu	Birim Fiyat (€)
Ex9UE2 20 1P 275 M	275	103344	43,20
Ex9UE2 20 1P 320 M	320	103752	44,77
Ex9UE2 20 1P 380 M	380	103753	91,42
Ex9UE2 20 1P 440 M	440	103345	101,81
Ex9UE2 40 NPE M	N-PE	103346	91,42

* Ürün tanımında "R" ibaresi bulunan ürünlerde bir üstündeki üründen farklı olarak sinyal kontağı bulunmaktadır.



NJMC1 Darbe Akım Anahtarı

Ürün Tanımı	In (A)	V (AC)	V (DC)	Sipariş Kodu	Birim Fiyat (€)	Kutu Adeti
1 Kutup	16	220		657012	18,70	12
	16		24	657011	21,98	12
	32	220		657014	27,29	12
	32		24	657013	27,29	12



Standart	IEC/EN 61810-1
Bobin Besleme Gerilimi	AC:220V ; DC:24V
Kontak Akımı	16/32A
Kutup	1 Kutuplu
Başlangıç Kontak Direnci	100m Ohm
Maksimum Anahtarlama	4000VA 448W (16A)
	8000VA 896 W (32 A)
Operasyon Süresi	≤20ms
Puls Gerilim Süresi	≥50ms
Kirlilik Seviyesi	1
Aşırı Gerilim Kategorisi	II
Sıcaklık Aralığı	-25...+550C

NCH8 Serisi Bina İçi Aydınlatma/Otomasyon Kontaktörü

DIN Ray Tipi



Sessiz Kontaktör AC- 1	In (A) 220/230 V AC 50/60 Hz	Yardımcı Kontakt	Sipariş Kodu	Birim Fiyat (€)	Kutu Adeti
2 Kutup	20 A	2NA	256054	15,59	8
	20 A	1NA +1NK	256052	15,59	8
	20 A	2NK	256053	15,59	8
	40 A	2NA	256081	40,58	6
	40 A	1NA +1NK	256083	40,58	6
	63 A	2NA	256093	50,77	6



Sessiz Kontaktör AC- 1	In (A) 220/230 V AC 50/60 Hz	Yardımcı Kontakt	Sipariş Kodu	Birim Fiyat (€)	Kutu Adeti
4 Kutup	20 A	4NA	256085	19,54	6
	20 A	2NA +2NK	256087	19,54	6
	25 A	4NA	256089	25,01	6
	25 A	2NA +2NK	256091	25,01	6
	40 A	4NA	256099	43,94	4
	63 A	4NA	256101	38,81	4
	63 A	3NA +1NK	256217	53,46	6
	63 A	2NA +2NK	256219	53,46	6



NKG3 Dijital Zaman Saati

IEC IEC/EN61095



Ürün Tanımı 220 V AC 50/60 Hz	Sipariş Kodu	Birim Fiyat (€)	Kutu Adeti
NKG3 8 ON veya 8 OFF Kontaklı	310024	55,15	1
Zaman Hassasiyeti	< 2 Saniye		
Zaman Rezervi	1 dakika-168 saat		
Mekanik Ömür	> 30.000		
Elektrik Ömür	>10.000		
Montaj Tip	Raya Montaj		
Gösterge	Dijital Ekran		

KG316T Dijital Zaman Saati

Enerjisiz Yazlık, Ofis ve Sokak Aydınlatmalarına Özel



Ürün Tanımı 220 V AC 50/60 Hz	Sipariş Kodu	Birim Fiyat (€)	Kutu Adeti
KG316T 8 ON veya 8 OFF Kontaklı	309009	67,98	1
Mekanik Ömür	1 X 10 5		
Elektrik Ömür	1 X 10 6		
Montaj Tip	Raya Montaj		
Gösterge	Dijital Ekran		



YENİ

ATR-100 Analog Zaman Saati



Programlama Tipi	Anahtarlama Süresi ve Aralık Tipi	Batarya	Program Süresi	Kontakt Tipi	Sipariş Kodu	Birim Fiyat (€)
Dikey Kadran-Günlük	15 Dakika / 1 Tırnak	100 Saat Rezervli	24 Saat	1 NA	500846	19,36



YENİ

CHD Serisi Astronomik Zaman Rölesi



Ürün Tanımı 230 V AC 50 Hz	Sipariş Kodu	Birim Fiyat (€)
CHD Serisi Astronomik Zaman Rölesi (RS-485 Haberleşmeli)	500879	95,00
Zaman Hassasiyeti	$\leq \pm 0,5$ saniye	
Mekanik Ömür	≥ 100.000	
Elektriksel Ömür	≥ 10.000	
Kontakt Sayısı ve Gücü	2 x 16A	
Montaj Tip	Raya Montaj	
Gösterge	Dijital Ekran	

NH4 Serisi Yük Ayırıcılar

IEC IEC/EN60947-3



	In (A) 230/400 V AC 50/60 Hz	Sipariş Kodu	Birim Fiyat (€)
1 Kutup	32	398037	4,53
	63	398038	4,77
	100	398036	7,03
	125	398032	8,15
2 Kutup	32	398040	9,76
	63	398041	10,89
	100	398039	12,78
	125	398033	13,53
3 Kutup	32	398043	12,34
	63	398044	13,84
	100	398042	16,88
	125	398034	18,60
4 Kutup	32	398046	16,53
	63	398047	18,45
	100	398045	23,07
	125	398035	24,41



RT28N-32 Serisi Sigorta Yuvaları (gG/gL Hızlı Tip Sigorta)



	Ürün Tanımı 230/400 V AC 50/60 Hz	Sipariş Kodu	Birim Fiyat (€)	Kutu Adeti
10 X 38 YUVALAR	1 Kutup	520484	2,92	12
	2 Kutup	520485	6,05	12
	3 Kutup	520486	8,56	12
gG/gL Silindirik Sigortalar 500 V AC	2A	520474	0,71	12
	4A	520475	0,71	12
	6A	520476	0,71	12
	10A	520478	0,71	10
	16A	520480	0,71	10
	20A	520481	0,71	10
	25A	520482	0,71	10
	32A	520483	0,73	10



NH17 Serisi Yatay Yük Ayırıcıları

IEC IEC/EN60947-4-1

Yatay | AC Sınıfı



	Ürün Tanımı	Uygun Sigorta	Sipariş Kodu	Birim Fiyat (€)
3 Kutup (Sigortasız)	100 A	Boy 00 Sigorta	403021	56,32
	160 A	Boy 00 ve Boy 0 Sigorta	403022	59,51
	250 A	80, 100, 125, 160, 200, 250	403023	106,27
	400 A	125, 160, 200, 250, 300, 315, 355, 400	403024	180,65
	630 A	315, 355, 400, 425, 500, 600	403025	210,83

NHRT40 Dikey Yük Ayırıcı

3 Faz



	Ürün Tanımı	Sipariş Kodu	Birim Fiyat (€)
Birlikte Ayırma	NHRT41-160/3L	842051	124,94
	NHRT41-250/3L	842052	242,66
	NHRT41-400/3L	842053	284,34
	NHRT41-630/3L	842054	338,30
Bağımsız Ayırma	NHRT41-160/3	842047	124,94
	NHRT41-250/3	842048	242,66
	NHRT41-400/3	842049	284,34
	NHRT41-630/3	842050	338,30



NH40 Serisi Yük Ayırıcıları

Yatay | AC/DC Sınıfı

3150A'e kadar sigortasız ayırıcı !



	Ürün Tanımı 400 V	Sipariş Kodu	Birim Fiyat (€)
3 Kutup	125A	393261	105,97
	250A	393264	164,87
	400A	393266	255,57
	630A	393267	331,39
	1000 A	393268	546,61
	1250A	393269	566,62
	1600 A	393270	641,00
	2000 A	393271	1.806,56
	2500 A	393272	2.058,41
	3150 A	393273	2.231,61
		NH40 Serisi için Yardımcı Kontak 1NA+1 NK	NH40-AU
	NH40 Serisi Metal Çubuk+Pano üstü Kol 630 a kadar	NH40-EXH1	122,06
	NH40 Serisi Metal Çubuk+Pano üstü Kol 1000-3150 a kadar	NH40-EXH2	185,81

NXZ Serisi Otomatik Transfer Şalterleri

IEC IEC/EN60947-6-1



Ürün Tanımı	Nominal Akım In (A)	Kutup sayısı	Kısa Devre Kesme Kapasitesi Icu (kA)	Sipariş Kodu	Birim Fiyat (€)
NXZM-63S/3B	10	3	25	256763	578,07
NXZM-63S/3B	16	3	25	256762	582,83
NXZM-63S/3B	25	3	25	256761	587,46
NXZM-63S/3B	32	3	25	256760	601,60
NXZM-63S/3B	40	3	25	256759	608,72
NXZM-63S/3B	50	3	25	256758	614,60
NXZM-63S/3B	63	3	25	256757	625,02
NXZM-125S/3B	80	3	25	256778	713,75
NXZM-125S/3B	100	3	25	256781	743,88
NXZM-125S/3B	125	3	25	256780	819,81
NXZM-160S/3B	160	3	35	256790	838,69
NXZM-250S/3B	180	3	35	256799	852,10
NXZM-250S/3B	200	3	35	256798	1.031,72
NXZM-250S/3B	225	3	35	256797	1.083,32
NXZM-250S/3B	250	3	35	256796	1.232,92
NXZM-400S/3B	315	3	50	256813	1.391,90
NXZM-400S/3B	350	3	50	256812	1.448,55
NXZM-400S/3B	400	3	50	256811	1.542,43
NXZM-630S/3B	500	3	50	256824	1.627,86
NXZM-630S/3B	630	3	50	256823	1.749,08
NXZM-800S/3B	700	3	50	256833	1.988,03
NXZM-800S/3B	800	3	50	256832	2.060,25
NXZM-63S/4B	10	4	25	256777	601,60
NXZM-63S/4B	16	4	25	256776	608,72
NXZM-63S/4B	25	4	25	256775	614,60
NXZM-63S/4B	32	4	25	256774	621,72
NXZM-63S/4B	40	4	25	256773	632,35
NXZM-63S/4B	50	4	25	256772	640,50
NXZM-63S/4B	63	4	25	256771	656,89
NXZM-125S/4B	80	4	25	256786	766,78
NXZM-125S/4B	100	4	25	256789	798,86
NXZM-125S/4B	125	4	25	256788	852,82
NXZM-160S/4B	160	4	35	256794	878,92
NXZM-250S/4B	180	4	35	256809	901,21
NXZM-250S/4B	200	4	35	256808	1.083,32
NXZM-250S/4B	225	4	35	256807	1.186,48
NXZM-250S/4B	250	4	35	256806	1.297,60
NXZM-400S/4B	315	4	50	256821	1.533,45
NXZM-400S/4B	350	4	50	256820	1.686,87
NXZM-400S/4B	400	4	50	256819	1.829,04
NXZM-630S/4B	500	4	50	256830	1.899,19
NXZM-630S/4B	630	4	50	256829	1.972,97
NXZM-800S/4B	700	4	50	256839	2.168,89
NXZM-800S/4B	800	4	50	256838	2.241,11

Kompakt Tip Devre Kesiciler



CHNT

NXM Serisi Devre Kesiciler

IEC IEC/EN60947-2

Sabit | Termik Manyetik | 3 Kutuplu

Nominal Akım In (A)	Ürün Tanımı	Kesme Kapasitesi Icu(kA)	Sipariş Kodu	Birim Fiyat (€)	Ürün Tanımı	Kesme Kapasitesi Icu(kA)	Sipariş Kodu	Birim Fiyat (€)
10	G NXM-63S/3300	25	205882	58,80	G NXM-63H/3300	50	205890	62,91
16	G NXM-63S/3300	25	205883	58,80	G NXM-63H/3300	50	205891	62,91
20	G NXM-63S/330	25	205884	58,80	G NXM-63H/3300	50	205892	62,91
25	G NXM-63S/3300	25	205885	58,80	G NXM-63H/3300	50	205893	62,91
32	G NXM-63S/3300	25	205886	58,80	G NXM-63H/3300	50	205894	62,91
40	G NXM-63S/3300	25	205887	58,80	G NXM-63H/3300	50	205895	62,91
50	G NXM-63S/3300	25	205888	58,80	G NXM-63H/3300	50	205896	62,91
63	G NXM-63S/3300	25	205889	58,80	G NXM-63H/3300	50	205897	62,91
80	G NXM-125S/3300	25	131361	68,49	G NXM-125H/3300	50	844290	73,28
100	G NXM-125S/3300	25	131362	70,69	G NXM-125H/3300	50	844283	75,63
125	G NXM-125S/3300	25	131363	75,05	G NXM-125H/3300	50	844284	80,30
160	G NXM-160S/3300	36	131364	91,77	G NXM-160H/3300	50	844323	98,18
200	G NXM-250S/3300	36	131367	113,39	G NXM-250H/3300	50	844331	121,23
225	G NXM-250S/3300	36	131368	122,47	G NXM-250H/3300	50	844332	131,23
250	G NXM-250S/3300	36	131369	125,04	G NXM-250H/3300	50	844333	133,91
315	G NXM-400S/3300	36	131371	259,27	G NXM-400H/3300	50	844355	277,22
400	G NXM-400S/3300	36	131373	287,02	G NXM-400H/3300	50	844358	307,14
500	G NXM-630S/3300	50	131374	354,19	G NXM-630H/3300	70	844369	379,16
630	G NXM-630S/3300	50	131375	369,88	G NXM-630H/3300	70	844370	395,67
800	G NXM-800S/3300	50	131376	865,00	G NXM-800H/3300	70	844379	925,56
1000	G NXM-1000S/3300	50	131377	1.009,34	G NXM-1000H/3300	70	844276	1.079,90
1250	G NXM-1250S/3300T	50	218740	1.398,29	G NXM-1250H/3300T	70	218742	1.496,21
1600	G NXM-1600S/3300T	50	131378	1.657,99	G NXM-1600H/3300T	70	844313	1.774,05



Sabit | Termik Manyetik | 4 Kutuplu

Nominal Akım In (A)	Ürün Tanımı	Kesme Kapasitesi Icu(kA)	Sipariş Kodu	Birim Fiyat (€)	Ürün Tanımı	Kesme Kapasitesi Icu(kA)	Sipariş Kodu	Birim Fiyat (€)
10	G NXM-63S/4300B	25	205906	95,16	G NXM-63H/4300B	50	205898	101,81
16	G NXM-63S/4300B	25	205907	95,16	G NXM-63H/4300B	50	205899	101,81
20	G NXM-63S/4300B	25	205908	95,16	G NXM-63H/4300B	50	205900	101,81
25	G NXM-63S/4300B	25	205909	95,16	G NXM-63H/4300B	50	205901	101,81
32	G NXM-63S/4300B	25	205910	95,16	G NXM-63H/4300B	50	205902	101,81
40	G NXM-63S/4300B	25	205911	95,16	G NXM-63H/4300B	50	205903	101,81
50	G NXM-63S/4300B	25	205912	95,16	G NXM-63H/4300B	50	205904	101,81
63	G NXM-63S/4300B	25	205913	95,16	G NXM-63H/4300B	50	205905	101,81
80	G NXM-125S/4300B	25	844310	103,01	G NXM-125H/4300B	50	844298	110,29
100	G NXM-125S/4300B	25	844303	106,79	G NXM-125H/4300B	50	844291	114,31
125	G NXM-125S/4300B	25	844304	111,22	G NXM-125H/4300B	50	844292	118,95
160	G NXM-160S/4300B	20	844328	128,45	G NXM-160H/4300B	50	844325	137,53
180	G NXM-250S/4300B	36	844340	139,89	G NXM-250H/4300B	50	844335	149,70
200	G NXM-250S/4300B	36	844341	144,96	G NXM-250H/4300B	50	844336	155,07
225	G NXM-250S/4300B	36	844342	155,07	G NXM-250H/4300B	50	844337	166,11
250	G NXM-250S/4300B	36	844343	164,14	G NXM-250H/4300B	50	844338	175,70
315	G NXM-400S/4300B	36	844364	378,54	G NXM-400H/4300B	50	844359	405,17
350	G NXM-400S/4300B	36	844366	373,48	G NXM-400H/4300B	50	844361	399,59
400	G NXM-400S/4300B	36	844367	408,87	G NXM-400H/4300B	50	844362	437,35
500	G NXM-630S/4300B	50	844376	612,74	G NXM-630H/4300B	70	844372	655,66
630	G NXM-630S/4300B	50	844377	656,80	G NXM-630H/4300B	70	844373	702,91
800	G NXM-800S/4300B	50	844384	901,11	G NXM-800H/4300B	70	844381	964,25
1000	G NXM-1000S/4300B	50	844281	1.045,24	G NXM-1000H/4300B	70	844278	1.118,49
1250	G NXM-1600S/4300TB	50	844320	1.982,35	G NXM-1600H/4300TB	70	844315	2.121,12
1600	G NXM-1600S/4300TB	50	844321	2.126,48	G NXM-1600H/4300TB	70	844316	2.275,36







Önemli Not: NXM serisi ürünler alttan giriş, üstten çıkış olacak şekilde montaja uygun değildir. Alttan giriş üstten çıkış bağlantı yapılması üründe hasara sebep olabilir.



NXM Serisi Devre Kesiciler

IEC IEC/EN60947-2

Aksesuarlar

	Ürün Tanımı	Besleme Gerilimi	Sipariş Kodu	Birim Fiyat (€)
	NXM-63/125 Sağ		946951	17,60
	NXM-160 Sol		946946	17,60
	NXM-160 Sağ		946949	17,60
	NXM-250/320 Sol		946944	19,90
	NXM-250/320 Sağ		946943	19,90
	NXM- 400/630 Sol		946941	47,16
	NXM- 800 Sol		946938	53,65
	NXM- 800 Sağ		946935	53,65
	NXM- 1250/1600 Sol		146145	64,90
	NXM-63/125 Sol	AC 230V	203834	51,32
	NXM-160 Sol	AC 230V	152863	51,32
	NXM-250/320 Sağ	AC 230V	152865	54,94
	NXM- 400/630 Sağ	AC 230V	946968	100,95
	NXM- 800 Sol	AC 230V	946978	114,22
	NXM- 1000 Sol	AC 230V	946985	124,84
	NXM- 1250/1600 Sol	AC 230V	946960	252,46
	NXM-63/125 Sol	AC 230V	946996	40,10
	NXM-63/125 Sağ	AC 230V	946958	40,10
	NXM-160 Sol	AC 230V	946953	40,10
	NXM-160 Sağ	AC 230V	946974	40,10
	NXM-250/320 Sol	AC 230V	946972	49,47
	NXM-250/320 Sağ	AC 230V	946969	49,47
	NXM- 400/630 Sağ	AC 230V	946966	91,85
	NXM- 800 Sağ	AC 230V	946981	106,58
	NXM- 1000 Sağ	AC 230V	946988	113,70
NXM- 1250/1600 Sol	AC 230V	946961	136,91	
	NXM-63/125 Sağ		201842	12,83
	NXM-160 Sol		946947	12,83
	NXM-160 Sağ		946950	12,83
	NXM-250/320 Sol		203836	12,83
	NXM- 400/630 Sol		946939	28,84
	NXM- 800 Sol		946937	30,30
	NXM- 800 Sağ		946934	30,30
	NXM- 1250/1600 Sağ		146146	30,30
	NXM-63/125	AC/DC 230V	946922	340,36
	NXM-160S	AC/DC 230V	946905	340,36
	NXM-160H	AC/DC 230V	946904	340,36
	NXM-250/320	AC/DC 230V	946926	360,38
	NXM- 400/630	AC/DC 230V	946912	648,85
	NXM- 800	AC/DC 230V	946908	720,97
	NXM- 1000	AC/DC 230V	946916	865,00
	NXM- 1250/1600	AC/DC 230V	946914	937,11
		NXM-63/125		946896
NXM-160			946886	52,64
NXM-250/320			946889	52,64
NXM- 400/630			946891	64,90
NXM- 800			946887	72,10
NXM- 1000			946894	79,30
NXM- 1250/1600			946892	100,95

* Kutup belirtilmeyen ürünler 3 ve 4 kutup için uygundur.

* Kesme kapasitesi modeli belirtilmeyen ürünler S ve H modelleri için uygundur.

NM8 Alçak Gerilim Devre Kesiciler

IEC IEC/EN60947-2

Ayarlı | Termik Manyetik | 3 Kutuplu



Ürün Tanımı	Kısa Devre Kesme Kapasitesi		Termik Ayar Sahası (A)	Manyetik Ayar Sahası (A)	Sipariş Kodu	Birim Fiyat (€)
	Icu (kA)	Ics (kA)				
NM8-125S 3 Kutup 16A T.M.Ş.	50	50	14-16	160	149678	100,60
NM8-125S 3 Kutup 20A T.M.Ş.	50	50	16-20	200	149679	100,60
NM8-125S 3 Kutup 25A T.M.Ş.	50	50	20-25	250	149680	100,25
NM8-125S 3 Kutup 32A T.M.Ş.	50	50	25-32	320	149681	100,25
NM8-125S 3 Kutup 40A T.M.Ş.	50	50	32-40	400	149682	100,25
NM8-125S 3 Kutup 50A T.M.Ş.	50	50	40-50	500	149683	100,25
NM8-125S 3 Kutup 63A T.M.Ş.	50	50	50-63	630	149684	100,25
NM8-125S 3 Kutup 80A T.M.Ş.	50	50	64-80	800	149685	100,25
NM8-125S 3 Kutup 100A T.M.Ş.	50	50	80-100	1000	149358	102,42
NM8-125S 3 Kutup 125A T.M.Ş.	50	50	100-125	1250	149676	122,21
NM8-250S 3 Kutup 160A T.M.Ş.	50	50	128-160	800-1600	149477	125,40
NM8-250S 3 Kutup 200A T.M.Ş.	50	50	160-200	1000-2000	149478	153,11
NM8-250S 3 Kutup 250A T.M.Ş.	50	50	200-250	1250-2500	149479	156,10
NM8-400S 3 Kutup 315A T.M.Ş.	70	70	252-315	1565-3150	149725	380,19
NM8-400S 3 Kutup 400A T.M.Ş.	70	70	320-400	2000-4000	149726	429,30
NM8-630S 3 Kutup 500A T.M.Ş.	70	70	400-500	2500-5000	149486	515,76
NM8S-630S 3 Kutup 630A T.M.Ş.	70	70	252-630	945-7560	149490	655,76
NM8-800S 3 Kutup 800A T.M.Ş.	50	25	640-800	4000-8000	149916	988,80
NM8-1250S 3 Kutup 1000A T.M.Ş.	50	25	800-1000	5000-10000	149858	1.382,82
NM8-1250S 3 Kutup 1250A T.M.Ş.	50	25	1000-1250	6250-12500	149856	1.709,87
NM8S-1600S 3kutup 1600A Elk. Açt. Ünt. T.M.Ş.	50	25	640-1600	2400-19200	263073	2.450,24



Ayarlı | Termik Manyetik | 4 Kutuplu



Ürün Tanımı	Kısa Devre Kesme Kapasitesi		Termik Ayar Sahası (A)	Manyetik Ayar Sahası (A)	Sipariş Kodu	Birim Fiyat (€)
	Icu (kA)	Ics (kA)				
NM8-125S 4 Kutup 32A T.M.Ş.	50	50	25-32	320	149934	162,07
NM8-125S 4 Kutup 40A T.M.Ş.	50	50	32-40	400	149935	162,07
NM8-125S 4 Kutup 50A T.M.Ş.	50	50	40-50	500	149936	162,07
NM8-125S 4 Kutup 63A T.M.Ş.	50	50	50-63	630	149937	162,07
NM8-125S 4 Kutup 80A T.M.Ş.	50	50	64-80	800	149938	176,94
NM8-125S 4 Kutup 100A T.M.Ş.	50	50	80-100	1000	149939	176,94
NM8-125S 4 Kutup 125A T.M.Ş.	50	50	100-125	1250	149940	200,74
NM8-250S 4 Kutup 160A T.M.Ş.	50	50	128-160	800-1600	149942	248,77
NM8-250S 4 Kutup 200A T.M.Ş.	50	50	160-200	1000-2000	149943	267,32
NM8-250S 4 Kutup 250A T.M.Ş.	50	50	200-250	1250-2500	149944	285,99
NM8-400S 4 Kutup 315A T.M.Ş.	70	70	252-315	1575-3150	149960	585,51
NM8-400S 4 Kutup 400A T.M.Ş.	70	70	320-400	2000-4000	149962	623,37
NM8-630S 4 Kutup 500A T.M.Ş.	70	70	400-500	2500-5000	149964	682,59
NM8-800S 4 Kutup 630A T.M.Ş.	50	25	504-630	3780-7560	149994	1.308,23
NM8-800S 4 Kutup 800A T.M.Ş.	50	25	640-800	4000-8000	149995	1.655,19
NM8-1250S 4 Kutup 1000A T.M.Ş.	50	25	800-1000	5000-10000	149996	2.501,41
NM8-1250S 4 Kutup 1250A T.M.Ş.	50	25	800 - 1250	6125-12500	150000	2.579,00



NM8 Serisi Alçak Gerilim Devre Kesiciler

IEC IEC/EN60947-2

Ayarlı | Termik Manyetik Yüksek Kesme Kapasitesi 100kA | 3 Kutup



Ürün Tanımı	Kısa Devre Kesme Kapasitesi		Termik Ayar Sahası (A)	Manyetik Ayar Sahası (A)	Sipariş Kodu	Birim Fiyat (€)
	Icu (kA)	Ics (kA)				
NM8-125H 3 Kutup 40A	100	100	32-40	400	149690	138,24
NM8-125H 3 Kutup 50A	100	100	40-50	500	149691	138,24
NM8-125H 3 Kutup 63A	100	100	50-63	630	149692	138,24
NM8-125H 3 Kutup 80A	100	100	64-80	800	149693	138,24
NM8-125H 3 Kutup 100A	100	100	80-100	1000	149694	138,24
NM8-125H 3 Kutup 125A	100	100	100-125	1250	149695	148,36
NM8-250H 3 Kutup 160A	100	100	128-160	800-1600	149470	190,45
NM8-250H 3 Kutup 200A	100	100	160-200	1000-2000	149471	257,73
NM8-250H 3 Kutup 250A	100	100	200-250	1250-2500	149472	264,99

Sadece Manyetik Korunmalı Devre Kesiciler | 3 Kutup



Ürün Tanımı	Kısa Devre Kesme Kapasitesi		Manyetik Ayar Sahası (A)	Sipariş Kodu	Birim Fiyat (€)
	Icu (kA)	Ics (kA)			
NM8-125S 3 kutup 32A 50kA	50	50	320	149410	148,36
NM8-125S 3 kutup 40A 50kA	50	50	400	149407	148,36
NM8-125S 3 kutup 50A 50kA	50	50	500	149409	148,36
NM8-125S 3 kutup 63A 50kA	50	50	630	149408	148,36
NM8-125S 3 kutup 80A 50kA	50	50	800	149406	148,36
NM8-125S 3 kutup 100A 50kA	50	50	1000	149405	148,36
NM8-125S 3 kutup 125A 50kA	50	50	1250	149404	226,47
NM8-250S 3 kutup 160A 50kA	50	50	800-1600	149416	226,47
NM8-250S 3 kutup 200A 50kA	50	50	1000-2000	149415	226,47
NM8-250S 3 kutup 250A 50kA	50	50	1250-2500	149414	226,47

NM8 Serisi Kompakt Tip Devre Kesiciler



Aksesuarlar

	Ürün Tanımı	Besleme Gerilimi	Sipariş Kodu	Birim Fiyat (€)	
	NM8-250 3P	NM8S-125, 250 3P	150760	194,27	
	NM8-125 3P		150761	165,91	
	NM8-125 4P		150875	165,91	
	NM8-250 4P	NM8S-125, 250 4P	150876	285,99	
	NM8 -400, 630 4P	NM8S-400, 630 4P	150878	690,33	
	NM8-400, 630 3P	NM8S-400, 630 3P	150892	572,60	
	NM8-125 3P		150763	8,42	
	NM8-250 3P	NM8S-125, 250 3P	150765	9,37	
	NM8-250 4P	NM8S-125, 250 4P	150766	9,75	
	NM8-125 4P		150767	10,31	
	NM8-125		220V AC	150848	57,01
	NM8-250, 400, 630	NM8S-125, 250, 400, 630	220V AC	150747	58,58
	NM8-800, 1250, 1600	NM8S-800, 1250, 1600	220V AC	150851	134,22
	NM8-125		24V DC	150847	100,87
	NM8-250,400,630	NM8S-125, 250, 400, 630	24V DC	150748	102,77
	NM8 -800, 1250, 1600	NM8S-800, 1250, 1600	24V DC	150753	160,64
	NM8-125		220V AC	150850	62,47
	NM8-250, 400, 630	NM8S-125, 250, 400, 630	220V AC	150750	62,47
	NM8 -800, 1250, 1600	NM8S-800, 1250, 1600	220V AC	150855	111,63
	NM8-250, 400, 630	NM8S-125, 250, 400, 630	24V DC	900330	93,63
	NM8 -800, 1250, 1600	NM8S-800, 1250, 1600	24V DC	900333	111,63
		Yardımcı kontak: Tüm NM8 serileri	Yardımcı kontak: Tüm NM8S serileri		150869
Alarm kontak: NM8 -125, 250, 400, 630		Alarm kontak: NM8S -125, 250, 400, 630		150870	22,52
Alarm kontak: NM8 -800, 1250		Alarm kontak: NM8S-800, 1250		900309	32,81
	NM8-125		220V AC/DC	150881	319,42
	NM8-250	NM8S-125,250	220V AC/DC	150882	319,42
	NM8 -400, 630	NM8S-400, 630	220V AC/DC	150884	734,17
	NM8 -800, 1250, 1600	NM8S-800, 1250, 1600	220V AC/DC	150890	757,08
	NM8-125			150902	35,16
	NM8-250			150903	35,16
	NM8-400, 630			150900	53,10
		NM8S-125, 250		150758	35,16
		NM8S-400, 630		150898	42,17
		NM8-125			150905
NM8-250				150896	70,29
NM8-400, 630				150909	74,17
		NM8S-125, 250		150759	50,77
		NM8S-400,630		150907	67,15
		NM8-125 3P			150773
	NM8-250 3P	NM8S-125, 250 3P		150775	49,19
	NM8 -400, 630 3P/4P	NM8S-400, 630 3P/4P		150777	65,58
	NM8 -800, 1250 3P/4P	NM8S-800, 1250 3P/4P		150910	132,68
		NM8S-125 4P		150912	57,01
	NM8-250 4P	NM8S-125, 250 4P		150913	57,01
	NM8-125 Asma Kilit			150839	9,91
	NM8-250 Asma Kilit	NM8S-125, 250 Asma Kilit		150840	10,62
	NM8 -400, 630 Asma Kilit	NM8S-400, 630 Asma Kilit		150842	10,62
	NM8 -1250 Asma Kilit	NM8S-1250 Asma Kilit		150844	11,34

* Kutup sayısı belirtilmeyen aksesuarlar; ilgili ürünün tüm kutupları için kullanılmaktadır.

* Aksesuar seçimi için ürünün nominal akım değerini değil, kasa boyutunu dikkate alınız.

Kaçak Akım Algılamalı (Yangın Koruma) Kompakt Tip Devre Kesiciler

IEC IEC/EN

4 Kutup | Dahili Açırma Bobinli



Ürün Tanımı	Kesme Kap. Icu (kA)	Kaçak Akım Ayar Sahası (mA)	Gecikme Süresi (s)	Sipariş Kodu	Birim Fiyat (€)
NXMLE-125H/4310 Y D 25A	36	200-300-500	0.3-0.4-0.5	948589	157,33
NXMLE-125H/4310 Y D 32A	36	200-300-500	0.3-0.4-0.5	948590	158,27
NXMLE-125H/4310 Y D 40A	36	200-300-500	0.3-0.4-0.5	948591	164,35
NXMLE-125H/4310 Y D 50A	36	200-300-500	0.3-0.4-0.5	948592	165,08
NXMLE-125H/4310 Y D 63A	36	200-300-500	0.3-0.4-0.5	948593	166,11
NXMLE-125H/4310 Y D 80A	36	200-300-500	0.3-0.4-0.5	948594	167,04
NXMLE-125H/4310 Y D 100A	36	200-300-500	0.3-0.4-0.5	948587	167,86
NXMLE-125H/4310 Y D 125A	36	200-300-500	0.3-0.4-0.5	948588	190,05
NXMLE-160S/4310 Y D 160A	35	200-300-500	0.3-0.4-0.5	948619	201,08
NXMLE-250S/4310 Y D 180A	35	200-300-500	0.3-0.4-0.5	948637	222,85
NXMLE-250S/4310 Y D 200A	35	200-300-500	0.3-0.4-0.5	948638	249,06
NXMLE-250S/4310 Y D 225A	35	200-300-500	0.3-0.4-0.5	948639	257,83
NXMLE-250S/4310 Y D 250A	35	200-300-500	0.3-0.4-0.5	948640	262,05
NXMLE-400S/4310 Y D 315A	50	200-300-500	0.3-0.4-0.5	948662	480,47
NXMLE-400S/4310 Y D 350A	50	200-300-500	0.3-0.4-0.5	948663	502,56
NXMLE-400S/4310 Y D 400A	50	200-300-500	0.3-0.4-0.5	948664	506,78
NXMLE-630S/4310 Y D 500A	50	200-300-500	0.3-0.4-0.5	948675	677,11
NXMLE-630S/4310 Y D 630A	50	200-300-500	0.3-0.4-0.5	948676	683,73

! Önemli Not: NXMLE serisi ürünler alttan giriş, üstten çıkış olacak şekilde montaja uygun değildir. Alttan giriş üstten çıkış bağlantı yapılması üründe hasara sebep olabilir.

*Gecikmesiz tip ve farkı kaçak akım ayar sahali ürünler için sorunuz.

NM8L Kaçak Korumalı 4 Kutuplu Kompakt Şalter

Kaçak Akım Korumalı Şalter



	Termik Manyetik Açırma Ünitesi 50 – 500mA	Kesme Kapasitesi Icu (kA)	Termik I (A)	Sipariş Kodu	Birim Fiyat (€)
NM8L -125S	25/4	50	20-25	169231	357,60
	32/4	50	26-32	169232	357,60
	40/4	50	33-40	169233	357,60
	50/4	50	40-50	169234	357,60
	63/4	50	51-63	169235	357,60
	80/4	50	64-80	169243	357,60
	100/4	50	81-100	169244	357,60
	125/4	50	101-125	150041	357,60
NM8L -250S	160/4	50	126-160	169299	449,93
	200/4	50	161-200	169300	476,97
	250/4	50	201-250	169301	486,25

Açık Tip Devre Kesiciler



CHNT

NA1-X Serisi (LSI Koruma)

IEC IEC/EN601947-2

Ayarlı | Elektronik



3 Kutup Sabit Tip

Ürün Tanımı	Kesme Kap. Icu (kA)	Ics (kA)	Termik Ayar Sahası Ir(A)	Sipariş Kodu	Birim Fiyat (€)
3 Kutup Sabit Tip NA1-2000XH 630A, 65kA	65	65	0,4-1*In	937394	1.873,72
3 Kutup Sabit Tip NA1-2000XH 800A, 65kA	65	65	0,4-1*In	937414	1.951,82
3 Kutup Sabit Tip NA1-2000XH 1000A, 65kA	65	65	0,4-1*In	937314	1.998,45
3 Kutup Sabit Tip NA1-2000XH 1250A, 65kA	65	65	0,4-1*In	937334	2.169,30
3 Kutup Sabit Tip NA1-2000XH 1600A, 65kA	65	65	0,4-1*In	937354	2.385,35
3 Kutup Sabit Tip NA1-2000XH 2000A, 65kA	65	65	0,4-1*In	937374	2.810,52
3 Kutup Sabit Tip NA1-3200XN 2500A, 65kA	65	65	0,4-1*In	937558	3.591,12
3 Kutup Sabit Tip NA1-3200XN 3200A, 65kA	65	65	0,4-1*In	937579	4.215,63
3 Kutup Sabit Tip NA1-4000X 4000A, 80kA	80	65	0,4-1*In	101164	7.026,04

*3 Kutup Sabit Tip 4000A ürünün Icu/Ics=%100 seçeneği için sorunuz.



4 Kutup Sabit Tip

Ürün Tanımı	Kesme Kap. Icu (kA)	Ics (kA)	Termik Ayar Sahası Ir(A)	Sipariş Kodu	Birim Fiyat (€)
4 Kutup Sabit Tip NA1-2000XH 1000A, 65kA	65	65	0,4-1*In	937324	2.966,41
4 Kutup Sabit Tip NA1-2000XH 1250A, 65kA	65	65	0,4-1*In	937344	3.122,61
4 Kutup Sabit Tip NA1-2000XH 1600A, 65kA	65	65	0,4-1*In	937364	3.356,93
4 Kutup Sabit Tip NA1-2000XH 2000A, 65kA	65	65	0,4-1*In	937384	3.513,13
4 Kutup Sabit Tip NA1-3200XN 2500A, 65kA	65	65	0,4-1*In	937566	4.527,82
4 Kutup Sabit Tip NA1-3200XN 3200A, 65kA	65	65	0,4-1*In	937587	5.308,54

4 Kutup Çekmeceli Tip

Ürün Tanımı	Kesme Kap. Icu (kA)	Ics (kA)	Termik Ayar Sahası Ir(A)	Sipariş Kodu	Birim Fiyat (€)
4 Kutup Çekmeceli Tip NA1-6300XN - 4000A, 100kA	100	100	0,4-1*In	937595	9.005,85

3 Kutup Çekmeceli Tip

Ürün Tanımı	Kesme Kap. Icu (kA)	Ics (kA)	Termik Ayar Sahası Ir(A)	Sipariş Kodu	Birim Fiyat (€)
3 Kutup Çekmeceli NA 1-2000XH 630A, 65kA	65	65	0,4-1*In	937392	2.342,01
3 Kutup Çekmeceli NA 1-2000XH 800A, 65kA	65	65	0,4-1*In	937412	2.342,01
3 Kutup Çekmeceli NA 1-2000XH 1000A, 65kA	65	65	0,4-1*In	937312	2.381,11
3 Kutup Çekmeceli NA 1-2000XH 1250A, 65kA	65	65	0,4-1*In	937332	2.439,00
3 Kutup Çekmeceli NA 1-2000XH 1600A, 65kA	65	65	0,4-1*In	937352	2.854,67
3 Kutup Çekmeceli NA 1-2000XH 2000A, 65kA	65	65	0,4-1*In	937372	3.414,59
3 Kutup Çekmeceli NA 1-3200XN 2500A, 65kA	65	65	0,4-1*In	937556	4.372,24
3 Kutup Çekmeceli NA 1-3200XN 3200A, 65kA	65	65	0,4-1*In	937577	4.968,37
3 Kutup Çekmeceli NA 1-6300XN 4000A, 100kA	100	100	0,4-1*In	937591	7.236,82
3 Kutup Çekmeceli NA 1-6300XN 5000A, 100kA	100	100	0,4-1*In	937599	14.051,98



Aksesuarlar



Ürün Tanımı	Tipi	Sipariş Kodu	Birim Fiyat (€)
Motor Mekanizması NA1-2000 Kasa	220 V AC	102944	348,31
Motor Mekanizması NA1 3200 ~ 4000 Kasa	220 V AC	102950	388,34
Motor Mekanizması NA1-6300 Kasa	220 V AC	102953	427,78
Açırma Bobini NA1-2000 ~ 6300 Kasa	220 V AC	102840	109,27
Kapama Bobini NA1-2000 ~ 6300 Kasa	220 V AC	102833	109,27
Düşük Gerilim Bobini NA1-2000 ~ 4000 Kasa	220 V AC	102851	109,27
Düşük Gerilim Bobini NA1-2000 ~ 6300 Kasa	220 V AC	102848	134,12
Gecikmeli Düşük Gerilim Bobini NA1-2000-4000	220 V AC	102857	140,63
NA1 Asma Kilit, Tek Kilitli	1 Kilit 1 Anahtar	102804	46,86
NA1 Asma Kilit, Üç Kilitli	3 Kilit 2 Anahtar	102806	46,86
NA1-2000-6300 Kablo Tipi Mekanik Kilit	Kablo	102789	579,83
NA1-2000~6300 Sabitleme Plakası		102894	3,61

! NA1 Serisi açık tip şalterlerde yardımcı kontak bloğu dahili olarak ürün üzerinde bulunmaktadır.

Mekanik kilit seçimi için mutlaka okuyunuz:

* Çekmeceli tip için sadece 1 adet 102789 sipariş edilmelidir. * Sabit tip için 1 adet 102789 ve 2 adet 102894 sipariş edilmelidir.

NA8G Serisi

Ayarlı | ZSI Özelliği

IEC IEC/EN601947-2



	Ürün Tanımı 400/690 V AC	Kesme Kap. Icu (kA)	Termik I (A)	Sipariş Kodu	Birim Fiyat (€)
Elektronik Kontrol Üniteli Sabit Tip 3 Kutuplu	NA8G-1600 1000 A	50	400-1000	111414	2.654,32
	NA8G-1600 1250 A	50	500-1250	111418	2.693,32
	NA8G-1600 1600 A	50	640-1600	111415	2.769,46
	NA8G-3200 2000 A	50	800-2000	111417	3.983,60
	NA8G-3200 2500 A	50	1000-2500	111421	4.293,73
	NA8G-3200 3200 A	50	1280-3200	111422	4.382,03



NA8G-Özellikler

- Arıza halinde sistemi zararlı etkilerden koruma
- Arıza anında yükü olabildiğince kısa sürede arıza akımına maruz bırakmak.
- Gereksiz triple açmaların önüne geçerek işletme güvenliğini sağlamak.
- Akıllı şebeke uygulamalarında.
- Alçak gerilim dağıtım panosunun akıllı şebekeye bağlantısı.
- Haberleşme yetenekleri sayesinde uzaktan erişim ve sistemin bakımını olanak sağlar.
- Bölgesel Seçicilik Kaskad Bağlantı (ZSI)
- Küçük ebatları sayesinde panoda minimum yer kaplar

Toroid Röle ve Akım Trafosu



	Ürün Tanımı 230/400 V AC	Sipariş Kodu	Birim Fiyat (€)
Toroid Röle	RDC -01 serisi 0.3-0.5A 1NA/1NK	900001	146,12
	RDC -02 serisi 0.025-25A 1NA/1NK	900002	232,23
Panoya Montaj Toroid Röle	RDC-11 serisi 0.025-2.5A 1NA/1NK	900004	250,83
Toroid	Akım trafosu TTC serisi toroid 60mm	900104	85,34
	Akım trafosu TTC serisi toroid 110mm	900101	163,41
	Akım trafosu TTC serisi toroid 160mm	900102	389,86
	Akım trafosu TTC serisi toroid 210mm	900103	436,52



RDC-03 Serisi Kaçak Akım Algılama Rölesi ve Akım Trafosu



	Ürün Tanımı 230/400 V AC	Sipariş Kodu	Birim Fiyat (€)
Toroid Röle	RDC-03 Serisi 0,03A-30A 1NA/1NK	500841	103,48
Toroidal Akım Trafoları	Akım Trafosu TTC-40 Serisi 40 mm	500842	31,49
	Akım Trafosu TTC-80 Serisi 80 mm	500843	37,17
	Akım Trafosu TTC-120 Serisi 120 mm	500844	52,88
	Akım Trafosu TTC-160 Serisi 160 mm	500845	96,53

AG Kuru Tip Kondansatörler

IEC IEC/EN60947-4-1



Monofaze Güç Kondansatörleri

Anma Gerilimi (V)	Anma Gücü (kVar)	Ürün Tanımı	Sipariş Kodu	Birim Fiyat (€)
230	0.25	NWC6-230V 0.25kvar 1P	799011	23,43
230	0.5	NWC6-230V 0.5kvar 1P	799012	23,86
230	1	NWC6-230V 1kvar 1P	799013	27,05
230	1.5	NWC6-230V 1.5kvar 1P	799014	33,09
230	2.5	NWC6-230V 2.5kvar 1P	799015	46,77
230	5	NWC6-230V 5kvar 1P	799016	90,04
230	7.5	NWC6-230V 7.5kvar 1P	799017	135,85
230	10	NWC6-230V 10kvar 1P	799018	174,07

Trifaze Güç Kondansatörleri

400	0.5	NWC6-400V 0.5kvar 3P	799019	29,39
400	1	NWC6-400V 1kvar 3P	799020	30,23
400	1.5	NWC6-400V 1.5kvar 3P	799021	34,36
400	2.5	NWC6-400V 2.5kvar 3P	799022	39,26
400	5	NWC6-400V 5kvar 3P	799023	41,00
400	7.5	NWC6-400V 7.5kvar 3P	799024	43,80
400	10	NWC6-400V 10kvar 3P	799025	46,53
400	15	NWC6-400V 15kvar 3P	799026	62,92
400	20	NWC6-400V 20kvar 3P	799029	80,41
400	25	NWC6-400V 25kvar 3P	799030	97,66
400	30	NWC6-400V 30kvar 3P	799031	107,10
450	5	NWC6-450V 5kvar 3P	799032	44,00
450	7.5	NWC6-450V 7.5kvar 3P	799033	46,85
450	10	NWC6-450V 10kvar 3P	799034	48,89
450	15	NWC6-450V 15kvar 3P	799035	60,74
450	20	NWC6-450V 20kvar 3P	799036	84,76
450	25	NWC6-450V 25kvar 3P	799037	89,59
450	30	NWC6-450V 30kvar 3P	799038	102,68
525	7.5	NWC6-525V 7.5kvar 3P	799040	49,38
525	10	NWC6-525V 10kvar 3P	799041	53,75
525	15	NWC6-525V 15kvar 3P	799042	67,74
525	20	NWC6-525V 20kvar 3P	799043	93,94
525	25	NWC6-525V 25kvar 3P	799044	120,09
525	30	NWC6-525V 30kvar 3P	799045	126,69

Şönt Reaktörler - Endüktif Yük Reaktörleri

IEC IEC/EN60947-4-1

Monofaze Şönt Reaktörler

Anma Gerilimi (V)	Anma Gücü (kVAr)	Ürün Tanımı	Sipariş Kodu	Birim Fiyat (€)
230	0.25	Shnt-230V 0.25kvar 1P	500001	84,82
230	0.3	Shnt-230V 0.3kvar 1P	500002	97,54
230	0.5	Shnt-230V 0.5kvar 1P	500003	114,50
230	1	Shnt-230V 1kvar 1P	500004	142,91
230	1.5	Shnt-230V 1.5kvar 1P	500005	197,15
230	2.5	Shnt-230V 2.5kvar 1P	500006	295,72
230	3.5	Shnt-230V 3.5kvar 1P	500007	443,55
230	5	Shnt-230V 5kvar 1P	500008	573,09
230	7	Shnt-230V 7kvar 1P	500009	641,83
230	7.5	Shnt-230V 7.5kvar 1P	500010	687,69
230	10	Shnt-230V 10kvar 1P	500011	916,93



Trifaze Şönt Reaktörler

Anma Gerilimi (V)	Anma Gücü (kVAr)	Bağlanabilen Şönt Reaktör	Ürün Tanımı	Sipariş Kodu	Birim Fiyat (€)
400	0.5		Shnt-400V 0.5kvar 3P	500012	223,48
400	1		Shnt-400V 1kvar 3P	500013	311,84
400	1.5		Shnt-400V 1.5kvar 3P	500014	345,18
400	2		Shnt-400V 2kvar 3P	500015	433,94
400	2.5		Shnt-400V 2.5kvar 3P	500016	447,00
400	3		Shnt-400V 3kvar 3P	500017	493,80
400	5		Shnt-400V 5kvar 3P	500018	732,86
400	7.5		Shnt-400V 7.5kvar 3P	500019	883,60
400	10		Shnt-400V 10kvar 3P	500020	1.159,04
400	12.5		Shnt-400V 12.5kvar 3P	500021	1.221,42
400	15		Shnt-400V 15.0kvar	500022	1.377,34
400	20		Shnt-400V 20kvar 3P	500023	1.715,22
400	25		Shnt-400V 25kvar 3P	500024	1.808,76
400	30		Shnt-400V 30kvar 3P	500025	1.871,14
400	40		Shnt-400V 40kvar 3P	500026	2.240,17
400	50		Shnt-400V 50kvar 3P	500027	3.206,90

Endüktif Yük Sürücü- SVC Yük Sürücü

Anma Gerilimi (V)	Anma Gücü (kVAr)	Bağlanabilen Şönt Reaktör	Ürün Tanımı	Sipariş Kodu	Birim Fiyat (€)
400	5	3 x 1.5kvar	5kvar SVC yük sürücü (3 x 1.5kvar)	500028	330,33
400	10	3 x 3.5kvar	10kvar SVC yük sürücü (3 x 3.5kvar)	500029	408,98
400	20	3 x 7kvar	20kvar SVC yük sürücü (3 x 7kvar)	500030	637,09
400	30	3 x 10kvar	30kvar SVC yük sürücü (3 x 10kvar)	500031	700,01

CJ19 Serisi Kompanzasyon Kontaktörleri

IEC IEC/EN60947-4-1

3 Kutup Sabit Tip



Ürün Tanımı	Yardımcı Kontakt	Sipariş Kodu	Birim Fiyat (€)
Cj19 serisi 3 kutup 7,5 kVAR	1NA+1NK	253731	32,83
CJ19 serisi 3 kutup 12kVAR	1NA+1NK	243764	42,08
CJ19 serisi 3 kutup 18kVAR	1NA+1NK	243881	53,68
CJ19 serisi 3 kutup 20kVAR	1NA+1NK	243998	54,14
CJ19 serisi 3 kutup 25 kVAR	1NA+2NK	253732	74,13
CJ19 serisi 3 kutup 30kVAR	1NA+2NK	244079	92,16
CJ19 serisi 3 kutup 40kVAR	1NA+2NK	253734	123,50
CJ19 serisi 3 kutup 50kVAR	1NA+2NK	244160	146,91

Harmonik Filtre Reaktörleri



Anma Gerilimi (V)	Anma Gücü (kVAr)	Rezonans Frekansı (Hz)	%p	Ürün Tanımı	Sipariş Kodu	Birim Fiyat (€)
400	0.83	189	%7	CHNTHFR-%7-189Hz 400V 0.83kvar	500032	111,84
400	1.5	189	%7	CHNTHFR-%7-189Hz 400V 1.5kvar	500033	132,16
400	2.5	189	%7	CHNTHFR-%7-189Hz 400V 2.5kvar	500034	158,59
400	5	189	%7	CHNTHFR-%7-189Hz 400V 5.0kvar	500035	203,31
400	6.25	189	%7	CHNTHFR-%7-189Hz 400V 6.25kvar	500036	213,47
400	10	189	%7	CHNTHFR-%7-189Hz 400V 10.0kvar	500037	239,16
400	12.5	189	%7	CHNTHFR-%7-189Hz 400V 12.5kvar	500038	256,42
400	15	189	%7	CHNTHFR-%7-189Hz 400V 15.0kvar	500039	276,14
400	20	189	%7	CHNTHFR-%7-189Hz 400V 20.0kvar	500040	345,62
400	25	189	%7	CHNTHFR-%7-189Hz 400V 25.0kvar	500041	374,76
400	30	189	%7	CHNTHFR-%7-189Hz 400V 30.0kvar	500042	416,78
400	40	189	%7	CHNTHFR-%7-189Hz 400V 40.0kvar	500043	473,68
400	50	189	%7	CHNTHFR-%7-189Hz 400V 50.0kvar	500044	508,25
400	75	189	%7	CHNTHFR-%7-189Hz 400V 75.0kvar	500046	746,12

Not: %p, %5,67 ve %14 değerli ürünler için sorunuz.

Motor Koruma ve Kontrol Ürünleri



CHNT

NC1 Serisi Kontaktörler

3 Kutup 220 VA AC



Ürün Tanımı	Anma Gücü P(kW)400V	Anma Akımı I(A) (AC3)	Termik Akım Ith(AC1)	Yardımcı Kontakt	Sipariş Kodu	Birim Fiyat (€)
NC1-0901M	4	9	20	1NK	220796	12,48
NC1-0910M	4	9	20	1NA	221029	12,48
NC1-1201M	5,5	12	20	1NK	221124	13,09
NC1-1210M	5,5	12	20	1NA	221355	13,09
NC1-1801M	7,5	18	32	1NK	221446	15,11
NC1-1810M	7,5	18	32	1NA	221541	15,11
NC1-2501M	11	25	40	1NK	221630	20,26
NC1-2510M	11	25	40	1NA	221861	20,26
NC1-3201M	15	32	50	1NK	221953	31,16
NC1-3210M	15	32	50	1NA	222048	31,16
NC1-4011M	18,5	40	60	1NA+1NK	222268	50,62
NC1-5011M	22	50	80	1NA+1NK	222489	60,74
NC1-6511M	30	65	80	1NA+1NK	222710	74,90
NC1-8011M	37	80	95	1NA+1NK	222931	96,56
NC1-9511M	45	95	95	1NA+1NK	223152	107,20

4 Kutup 220 VA AC



Ürün Tanımı	Anma Gücü P(kW)400V	Anma Akımı I(A) (AC3)	Termik Akım Ith(AC1)	Sipariş Kodu	Birim Fiyat (€)
NC1-0904M	4	9	20	220890	14,85
NC1-1204M	5,5	12	20	221216	17,03
NC1-2504M	11	25	40	221722	25,79
NC1-4004M	18,5	40	60	222139	67,93
NC1-5004M	22	50	80	222360	77,50
NC1-6504M	30	65	80	222581	90,72
NC1-8004M	37	80	95	222802	120,82
NC1-9504M	45	95	95	223023	127,21

NC1 Serisi Kontaktörler

3 Kutup 24 VDC



Ürün Tanımı	Anma Gücü P(kW)400V	Anma Akımı I(A) (AC3)	Termik Akım Ith(AC1)	Yardımcı Kontakt	Sipariş Kodu	Birim Fiyat (€)
NC1-0901Z	4	9	20	1NK	220881	25,59
NC1-0910Z	4	9	20	1NA	221112	25,59
NC1-1201Z	5.5	12	20	1NK	221207	27,88
NC1-1210Z	5.5	12	20	1NA	221437	27,88
NC1-1801Z	7.5	18	32	1NK	221529	29,34
NC1-1810Z	7.5	18	32	1NA	221621	29,34
NC1-2501Z	11	25	40	1NK	221713	41,33
NC1-2510Z	11	25	40	1NA	221944	41,33
NC1-3201Z	15	32	50	1NK	222036	55,44
NC1-3210Z	15	32	50	1NA	222130	55,44
NC1-4011Z	18.5	40	60	1NA + 1NK	222351	99,54
NC1-5011Z	22	50	80	1NA + 1NK	222572	106,99
NC1-6511Z	30	65	80	1NA + 1NK	222793	124,74
NC1-8011Z	37	80	95	1NA + 1NK	223014	152,29
NC1-9511Z	45	95	95	1NA + 1NK	223235	170,12

3 Kutup 24 VAC



Ürün Tanımı	Anma Gücü P(kW)400V	Anma Akımı I(A) (AC3)	Termik Akım Ith(AC1)	Yardımcı Kontakt	Sipariş Kodu	Birim Fiyat (€)
NC1-0901 24V 50/60Hz	4	9	20	1NK	220805	12,50
NC1-0910 24V 50/60Hz	4	9	20	1NA	221038	12,50
NC1-1201 24V 50/60Hz	5.5	12	20	1NK	221133	13,14
NC1-1210 24V 50/60Hz	5.5	12	20	1NA	221363	13,14
NC1-1801 24V 50/60Hz	7.5	18	32	1NK	221455	15,18
NC1-1810 24V 50/60Hz	7.5	18	32	1NA	221550	15,18
NC1-2501 24V 50/60Hz	11	25	40	1NK	221639	20,31
NC1-2510 24V 50/60Hz	11	25	40	1NA	221870	20,31
NC1-3201 24V 50/60Hz	15	32	50	1NK	221962	31,24
NC1-3210 24V 50/60Hz	15	32	50	1NA	222056	31,24
NC1-4011 24V 50/60Hz	18.5	40	60	1NA + 1NK	222277	50,77
NC1-5011 24V 50/60Hz	22	50	80	1NA + 1NK	222498	60,91
NC1-6511 24V 50/60Hz	30	65	80	1NA + 1NK	222719	75,12
NC1-8011 24V 50/60Hz	37	80	95	1NA + 1NK	222940	96,82
NC1-9511 24V 50/60Hz	45	95	95	1NA + 1NK	223161	107,50

NC1 Serisi Kontaktörler



3 Kutup 110 VAC

Ürün Tanımı	Anma Gücü P(kW)400V	Anma Akımı I(A) (AC3)	Termik Akım Ith(AC1)	Yardımcı Kontak	Sipariş Kodu	Birim Fiyat (€)
NC1-0901 110V 50/60Hz	4	9	20	1NK	220787	12,50
NC1-0910 110V 50/60Hz	4	9	20	1NA	221020	12,50
NC1-1201 110V 50/60Hz	5.5	12	20	1NK	221115	13,14
NC1-1210 110V 50/60Hz	5.5	12	20	1NA	221346	13,14
NC1-1801 110V 50/60Hz	7.5	18	32	1NK	221440	15,18
NC1-1810 110V 50/60Hz	7.5	18	32	1NA	221532	15,18
NC1-2501 110V 50/60Hz	11	25	40	1NK	221624	20,31
NC1-2510 110V 50/60Hz	11	25	40	1NA	221852	20,31
NC1-3201 110V 50/60Hz	15	32	50	1NK	221947	31,24
NC1-3210 110V 50/60Hz	15	32	50	1NA	222039	31,24
NC1-4011 110V 50/60Hz	18.5	40	60	1NA + 1NK	222259	50,77
NC1-5011 110V 50/60Hz	22	50	80	1NA + 1NK	222480	60,91
NC1-6511 110V 50/60Hz	30	65	80	1NA + 1NK	222701	75,12
NC1-8011 110V 50/60Hz	37	80	95	1NA + 1NK	222922	96,82
NC1-9511 110V 50/60Hz	45	95	95	1NA + 1NK	223143	107,50



NC1 Serisi Yardımcı Aksesuarlar



Açıklama	Termik Akım Ith (A) AC1	Yardımcı Kontak	Sipariş Kodu	Birim Fiyat (€)	Kutu Adeti	
Yardımcı Kontak Bloğu	F4-22	10	2NA+2NK	257019	5,53	10
	F4-02	10	2NK	257020	3,36	10
	F4-04	10	4NK	257021	5,53	10
	F4-11	10	1NA+1NK	257022	3,36	10
	F4-13	10	1NA+3NK	257023	5,53	10
	F4-20	10	2NA	257024	3,36	10
	F4-31	10	3NA+1NK	257025	5,53	10
	F4-40	10	4NA	257026	5,53	10
Yardımcı Kontak Yana Takılan Tip	NCF1-11C	10	1NA+1NK	223238	7,26	10

Açıklama	Sipariş Kodu	Birim Fiyat (€)	
Mekanik Kilit	NC1-09-32 Mekanik kilit	256717	7,57
	NC1-40-65 (3P) Mekanik kilit	777989	9,01
	NC1-80-95 (3P, 4P) & NC1-4004-6504 (4P) Mekanik kilit	777988	10,60



NXC Serisi Kontaktörler

3 Kutup 220V AC



Ürün Tanımı	Anma Gücü P(kW)400V	Anma Akımı I(A) (AC3)	Termik Akım Ith(AC1)	Yardımcı Kontakt	Sipariş Kodu	Birim Fiyat (€)
NXC-09 220V 50/60Hz	4	9	20	1NA+1NK	925353	12,78
NXC-12 220V 50/60Hz	5.5	12	25	1NA+1NK	925479	13,39
NXC-18 220V 50/60Hz	7.5	18	32	1NA+1NK	925607	15,62
NXC-25 220V 50/60Hz	11	25	40	1NA+1NK	925735	21,41
NXC-32 220V 50/60Hz	15	32	50	1NA+1NK	925213	33,01
NXC-38 220V 50/60Hz	18,5	38	50	1NA+1NK	925859	39,51
NXC-40 220V 50/60Hz	18,5	40	60	1NA+1NK	925923	50,62
NXC-50 220V 50/60Hz	22	50	80	1NA+1NK	925986	60,74
NXC-65 220V 50/60Hz	30	65	80	1NA+1NK	938049	74,90
NXC-75 220V 50/60Hz	37	75	90	1NA+1NK	938113	96,47
NXC-85 220V 50/60Hz	37	85	100	1NA+1NK	938177	103,17
NXC-100 220V 50/60Hz	45	100	110	1NA+1NK	925416	107,20
G NXC-120 220V 50/60Hz(R)	55	120	200	2NA+2NK	925250	189,20
G NXC-160 220V 50/60Hz(R)	75	160	200	2NA+2NK	925254	206,79
G NXC-185 220V 50/60Hz(R)	90	185	275	2NA+2NK	925258	269,49
G NXC-225 220V 50/60Hz(R)	110	225	275	2NA+2NK	925262	324,15
G NXC-265 AC/DC 220V-240V(R)	132	265	315	2NA+2NK	836542	378,30
G NXC-330 AC/DC 220V-240V(R)	160	330	380	2NA+2NK	836545	535,74
G NXC-400 AC/DC 220V-240V(R)	200	400	450	2NA+2NK	836548	537,41
G NXC-500 AC/DC 220V-240V(R)	250	500	630	2NA+2NK	836560	890,29
G NXC-630 AC/DC 220V-240V(R)	335	630	700	2NA+2NK	836563	1.118,74

NXC Serisi Yardımcı Aksesuarlar



Açıklama	Termik Akım Ith (A) AC1	Yardımcı Kontakt	Sipariş Kodu	Birim Fiyat (€)	Kutu Adeti	
Yardımcı Kontakt Bloğu	AX-3X/22	10	2NA+2NK	938251	5,53	10
	AX-3X/31	10	3NA+1NK	938252	5,53	10
	AX-3X/13	10	1NA+3NK	938253	5,53	10
	AX-3X/40	10	4NA	938254	5,53	10
	AX-3X/04	10	4NK	938255	5,53	10
	AX-3X/11	10	1NA+1NK	938256	3,36	10
	AX-3X/02	10	2NK	938257	3,36	10
	AX-3X/20	10	2NA	938258	3,36	10
Yardımcı Kontakt Bloğu Yana Takılan Tip	AX-3C/11	10	1NA+1NK	938259	7,26	10
Mekanik Kilit	Açıklama		Sipariş Kodu	Birim Fiyat (€)		
	NXC-09-38 Mekanik kilit		256717	7,57		
	NXC-40-65 Mekanik kilit		777989	9,01		
	NXC-75-100 Mekanik kilit		777988	10,60		

NC2 Serisi Kontaktörler

AC-1 AC-3 AC-4 Sınıfı



	Ürün Adı	Anma Gücü P(kW). 400 V AC	Anma Akımı I (A). AC3	Termik Akım Ith (A) AC1	Sipariş Kodu	Birim Fiyat (€)
3 Kutuplu 220 V AC	NC2-115M	55	115	200	671433	187,46
	NC2-150M	75	150	200	671398	204,90
	NC2-185M	90	185	275	671435	267,01
	NC2-225M	110	225	275	671400	321,18
	NC2-265M	132	265	315	236732	374,83
	NC2-330M	160	330	380	236055	530,83
	NC2-400M	200	400	450	236154	532,48
	NC2-500M	250	500	630	236254	882,12
	NC2-630M	335	600	800	236304	1.108,48
4 Kutuplu 220 V AC	NC2-115M4	55	115	200	671434	257,73
	NC2-150M4	75	150	200	671399	281,66
	NC2-185M4	90	185	275	671436	363,06
	NC2-225M4	110	225	275	671401	374,83
	NC2-265M4	132	265	315	671403	548,26
	NC2-330M4	160	330	380	236103	718,29
	NC2-400M4	200	400	450	236203	762,14
	NC2-630M4	335	600	800	236352	1.310,91



NC2 Serisi Kontaktör Aksesuarları



	Ürün Adı	Yardımcı Kontakt	Sipariş Kodu	Birim Fiyat (€)	Kutu Adeti
Yardımcı Kontakt Bloğu	NCF4-20	2NA	257024	3,38	10
	NCF4-02	2NK	257020	3,38	10
	NCF4-11	1NA+1NK	257022	3,38	10
	NCF4-40	4NA	257026	5,53	10
	NCF4-04	4NK	257021	5,53	10
	NCF4-22	2NA+2NK	257019	5,53	10
	NCF4-13	1NA+3 NK	257023	5,53	10
	NCF4-31	3NA+1 NK	257025	5,53	10

		Ayar Sahası	Geciktirme	Sipariş Kodu	Birim Fiyat (€)	
Zaman Rölesi	NCF5-T0	0,1s-3s	Çekme	1NA+1NK	258021	32,81
	NCF5-T2	0,1s-30s	Çekme	1NA+1NK	258022	32,81
	NCF5-T4	10s-180s	Çekme	1NA+1NK	258023	32,81
	NCF5-D0	0,1s-3s	Düşme	1NA+1NK	258018	32,81
	NCF5-D2	0,1s-30s	Düşme	1NA+1NK	258019	32,81
	NCF5-D4	10s-180s	Düşme	1NA+1NK	258020	32,81

	Ürün Adı	Uyumlu Kontaktörler	Sipariş Kodu	Birim Fiyat (€)
Yatay Mekanik Kilit	NC2-H01	NC2-115/150	237995	16,25
	NC2-H02	NC2-185/225	237997	25,33
	NC2-H03	NC2-265/330/400/500	237999	28,92
	NC2-H04	NC2-630	237993	47,42
Bobinler	NC2-115/150 220V AC		671926	39,05
	NC2-185/225 220V AC		671924	46,77
	NC2-265/330 220V AC		671992	71,06
	NC2-400 220V AC		671998	95,48
	NC2-500 220V AC		671997	98,02
	NC2-630 220V AC		671996	122,06



Termik Röleler

NC1 Kontaktör Serisine Uyumlu Termik Röleler



Termikler	Uyumlu Kontaktörler	Termik Ayar Sahası	Sipariş Kodu	Birim Fiyat (€)
NR2-25/0.16	NC1-09...32	0,1-0,16 A	268132	18,34
NR2-25/0.25	NC1-09...32	0,16-0,25 A	268133	18,34
NR2-25/0.4	NC1-09...32	0,25-0,40 A	268134	18,34
NR2-25/0.63	NC1-09...32	0.40-0,63 A	268135	18,34
NR2-25/1	NC1-09...32	0,63-1 A	268136	18,34
NR2-25/1.6	NC1-09...32	1-1.6 A	268137	18,34
NR2-25/2	NC1-09...32	1,25-2 A	268138	18,34
NR2-25/2.5	NC1-09...32	1.6-2,5 A	268131	18,34
NR2-25/4	NC1-09...32	2,5-4 A	268139	18,34
NR2-25/6	NC1-09...32	4-6 A	268140	18,34
NR2-25/8	NC1-09...32	5,5-8A	268141	18,34
NR2-25/10	NC1-09...32	7-10 A	268096	18,34
NR2-25/13	NC1-09...32	9-13 A	268095	18,34
NR2-25/18	NC1-09...32	12-18 A	268097	18,34
NR2-25/25	NC1-09...32	17-25 A	268142	18,34
NR2-36/32	NC1-32	23-32 A	268143	24,19
NR2-36/36	NC1-32	28-36 A	268144	25,18
NR2-93/32	NC1-40...95	23-32 A	268145	33,47
NR2-93/40	NC1-40...95	30-40 A	268146	34,15
NR2-93/50	NC1-40...95	37-50 A	268147	34,82
NR2-93/65	NC1-40...95	48-65 A	268148	35,52
NR2-93/70	NC1-40...95	55-70 A	268149	57,24
NR2-93/80	NC1-40...95	63-80 A	268150	59,64
NR2-93/93	NC1-40...95	80-93 A	268151	72,74

Ürün Tanımı	Uyumlu Termik	Sipariş Kodu	Birim Fiyat (€)	
DIN Raya Montaj Bloğu	MB-4	NR2-93	837996	11,36
	MB-3	NR2-36	837997	4,64
	MB-2	NR2-25	837998	3,72



NXC Kontaktör Serisine Uyumlu Termik Röleler



Termikler	Termik Ayar Sahası	Sipariş Kodu	Birim Fiyat (€)
NXR-25 0.1-0.16A	0,1-0,16 A	837105	13,93
NXR-25 0.16-0.25A	0,16-0,25 A	837106	13,93
NXR-25 0.25-0.4A	0,25-0,40 A	837107	13,93
NXR-25 0.4-0.63A	0.40-0,63 A	837108	13,93
NXR-25 0.63-1A	0,63-1 A	837109	13,93
NXR-25 1-1.6A	1-1.6 A	837110	13,93
NXR-25 1.25-2A	1,25-2 A	837111	13,93
NXR-25 1.6-2.5A	1.6-2,5 A	837112	13,93
NXR-25 2.5-4A	2,5-4 A	837113	13,93
NXR-25 4-6A	4-6 A	837114	13,93
NXR-25 5.5-8A	5,5-8A	837115	13,93
NXR-25 7-10A	7-10 A	837116	13,93
NXR-25 9-13A	9-13 A	837117	13,93
NXR-25 12-18A	12-18 A	837118	13,93
NXR-25 17-25A	17-25 A	837119	13,93
NXR-38 23A-32A	23-32A	837120	15,57
NXR-38 30A-38A	30-38A	837121	15,79
NXR-100 23A-32A	23-32A	837122	22,91
NXR-100 30A-40A	30-40A	837123	23,94
NXR-100 37A-50A	37-50A	837124	24,45
NXR-100 48A-65A	48-65A	837125	24,76
NXR-100 55A-70A	55-70A	837126	25,28
NXR-100 63A-80A	63-80A	837127	27,65
NXR-100 80A-93A	80-93A	837128	28,68
NXR-100 80A-100A	80-100A	837129	32,91

Ürün Tanımı	Uyumlu Termik	Sipariş Kodu	Birim Fiyat (€)	
DIN Raya Montaj Bloğu	MB-4	NXR-100	837996	11,36
	MB-3	NXR-38	837997	4,64
	MB-2	NXR-25	837998	3,72
	MB-1	NXR-12	837999	3,09

Daha büyük akım değerleri için sorunuz.

NC2 Kontaktör Serisine Uyumlu Termik Röleler

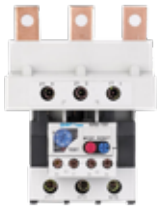

Termikler	Uyumlu Kontaktörler	Termik Ayar Sahası	Sipariş Kodu	Birim Fiyat (€)
NR2-150	NC2-115..120	80-104A	268292	105,85
NR2-150	NC2-115..120	95-120A	268293	111,74
NR2-150	NC2-115..120	110-150A	268294	117,61
NR2-200	NC2-115..225	80-125A	268295	159,82
NR2-200	NC2-115..225	100-160A	268296	168,17
NR2-200	NC2-115..225	125-200A	268297	176,63
NR2-630	NC2-185..630	160-250A	268298	193,45
NR2-630	NC2-185..630	200-315A	268299	199,43
NR2-630	NC2-185..630	250-400A	268300	260,72
NR2-630	NC2-185..630	315-500A	268301	318,59
NR2-630	NC2-185..630	400-630A	268302	346,97

NXC Serisi Mini Kontaktörler



Ürün Tanımı	Anma Gücü P(kW). 400 V AC	Anma Akımı I (A). AC3	Termik Akım Ith (A) AC1	Yardımcı Kontakt	Sipariş Kodu	Birim Fiyat (€)	Kutu Adeti	
3 Kutuplu 220 V AC	NXC-06M10	2,2	6	20	1NA	836572	11,55	1
	NXC-09M10	4	9	20	1NA	836576	12,07	1
	NXC-12M10	5,5	12	20	1NA	836580	12,69	1
	NXC-16M10	7,5	16	22	1NA	171735	19,20	1
3 Kutuplu 24 V DC	NXC-06M10/Z	2,2	6	20	1NA	836657	18,57	1
	NXC-09M10/Z	4	9	20	1NA	836660	20,12	1
	NXC-12M10/Z	5,5	12	20	1NA	836663	21,67	1
	NXC-16M10/Z	7,5	16	22	1NA	171740	23,21	1
Yardımcı Kontakt Bloğu	AX-3M/40			10	4NA	925184	5,52	
	AX-3M/31			10	3NA+1NK	925185	5,52	
	AX-3M/22			10	2NA+2NK	925186	5,52	
	AX-3M/13			10	1NA+3NK	925187	5,52	
	AX-3M/04			10	4NK	925188	5,52	
	AX-3M/20			10	2NA	925189	3,29	
	AX-3M/11			10	1NA+1NK	925190	3,29	
	AX-3M/02			10	2NK	925191	3,29	



NC6 Serisi Mini Kontaktörler

AC-1 AC-3 AC-4 Sınıfı



Ürün Tanımı	Anma Gücü P(kW). 400 V AC	Anma Akımı I (A). AC3	Termik Akım Ith (A) AC1	Yardımcı Kontakt	Sipariş Kodu	Birim Fiyat (€)	Kutu Adeti	
3 Kutuplu 220 V AC	NC6-0610M	2,2	6	20	1NA	247436	11,55	1
	NC6-0601M	2,2	6	20	1NK	247337	11,55	1
	NC6-0910M	4	9	20	1NA	247568	12,07	1
	NC6-0901M	4	9	20	1NK	247469	12,07	1
3 Kutuplu 24 V AC	NC6-0610M	2,2	6	20	1NA	247445	18,57	1
	NC6-0601M	2,2	6	20	1NK	247346	18,57	1
	NC6-0910M	4	9	20	1NA	247576	20,12	1
	NC6-0901M	4	9	20	1NK	247478	20,12	1
Yardımcı Kontakt Bloğu	NCF6-20			10	2NA	261006	6,89	2
	NCF6-02			10	2NK	261002	6,89	2
	NCF6-11			10	1NA+1NK	261004	6,89	2
	NCF6-40			10	4NA	261009	8,80	2
	NCF6-04			10	4NK	261003	8,80	2
	NCF6-22			10	2NA+2NK	261007	8,80	2
	NCF6-13			10	1NA+3 NK	261005	8,80	2
	NCF6-31			10	3NA+1 NK	261008	8,80	2
Mini Termik	NR2-11.5/0.16			0.1-0.16 A	1NA+1NK	268165	20,61	2
	NR2-11.5/0.25			0.16-0.25A	1NA+1NK	268166	20,61	2
	NR2-11.5/0.4			0.25-0.4 A	1NA+1NK	268167	20,61	2
	NR2-11.5/0.63			0.4-0.63A	1NA+1NK	268168	20,61	2
	NR2-11.5/1			0.63-1 A	1NA+1NK	268169	20,61	2
	NR2-11.5/1.6			1.0-1,6 A	1NA+1NK	268170	20,61	2
	NR2-11.5/2			1.25-2 A	1NA+1NK	268171	20,61	2
	NR2-11.5/2.5			2.0-2.5 A	1NA+1NK	268172	20,61	2
	NR2-11.5/4			2.5-4 A	1NA+1NK	268173	20,61	2
	NR2-11.5/6			4-6 A	1NA+1NK	268174	20,61	2
	NR2-11.5/8			5.5-8 A	1NA+1NK	268175	20,61	2
	NR2-11.5/10			7-10 A	1NA+1NK	268176	20,61	2
	NR2-11.5/13			9-13 A	1NA+1NK	268177	20,61	2



Uyumlu Termik					Birim Fiyat (€) (2 li Kutu)	
DIN raya Montaj Bloğu	NAD-11.5		NR2-11.5	837999	3,09	1



NS2X Serisi Motor Koruma Şalterleri

Termik Manyetik



Ürün Tanımı	Anma Gücü P(kW). 400 V AC	Kesme Kap. Icu (kA). 400 V AC	Termik Akım Ith (A) AC1	Sipariş Kodu	Birim Fiyat (€)	
3 Kutuplu 220 V AC	NS2-25X	-	100	0.1-0.16 A	495176	27,35
		-	100	0.16-0.25 A	495177	27,35
		-	100	0.25-0.4 A	495178	27,35
		-	100	0.4-0.63 A	495179	28,92
		--	100	0.63-1 A	495180	28,92
		0.37	100	1-1.6 A	495181	28,92
		0.75	100	1.6-2,5 A	495182	28,92
		1,5	100	2,5-4 A	495183	28,92
		2,2	100	4-6,3 A	495184	30,10
		4,0	100	6-10 A	495185	30,10
		5,5	15	9-14 A	495186	30,46
		7,5	15	13-18 A	495187	31,24
		11,0	15	17-23 A	495188	32,02
		11,0	15	20-25 A	495189	32,02
NS2-80B	15,0	15	24-32 A	139373	47,42	
	18,5	15	25-40 A	495087	90,26	
	30,0	15	40-63 A	495088	96,17	
	37,0	15	63-80 A	495089	133,29	

NS2 Serisi Motor Koruma Şalterleri Aksesuarları

			Çalışma Sahası	Gerilim	Sipariş Kodu	Birim Fiyat (€)
Düşük Gerilim Açtırma	NS2-UV380	-	%35-%70	380V	495989	16,56
	NS2-UV220	-	%35-%70	220V	495986	16,56
Uzaktan Açtırma	NS2-SH380	-	%70-%110	380V	495980	16,56
	NS2-SH220	-	%70-%110	220V	495977	16,56
Yardımcı Kontak üstüne Montaj	NS2-AE20	-	2NA	2.5A	495948	5,95
	NS2-AE11	-	1NA+1 NK	2.5A	495968	5,95
Yardımcı Kontak sağ/ sola Montaj	NS2-AU20	-	2NA	6A	495951	9,30
	NS2-AU11	-	1NA+1 NK	6A	495996	9,30
	NS2-80B-AU11 (NS2-80B içindir)	-	1NA+1 NK	6A	495972	9,30
Hata ve Ani Açtırma Kontakları-sola Montaj	NS2-FA0110	-	1NA+1 NK	6A	495956	10,04
	NS2-FA1010	-	1NA+1 NA	6A	495962	10,04
IP Sınıfı Yüksek Kutular	NS2-MC01	-	Suya Karşı Koruma Sınıfı Yüksek stop Butonlu Kutu		495945	26,18
	NS2-MC	-	Suya Karşı Kouması Yüksek		495997	20,51



NQ3 Serisi Kutulu Yolvericiler

Termik Korumalı



	Ürün Tanımı	Anma Gücü P(kW). 400 V AC	Ayar Sahası	Sipariş Kodu	Birim Fiyat (€)
400 VAC 50/60 Hz (Kontrol Gerilimi 380 V AC)	NQ3-5.5P 380 V/1.6A	-	1-1,6	496436	50,94
	NQ3-5.5P 380 V/2.5A	-	1,6-2,5	496440	50,94
	NQ3-5,5P 380 V/4A	-	2,5-4	496442	50,94
	NQ3-5,5 P 380 V/6A	5,5	4-6,0	496443	52,96
	NQ3-5,5 P 380 V/8A	5,5	5,5-8	496444	52,96
	NQ3-5,5 P 380 V/10A	5,5	7-10,0	496437	52,96
	NQ3-5,5 P 380 V/13A	5,5	9-13,0	496438	52,96
	NQ3-11/2 380 V/18A	11	12-18,0	496359	71,87
	NQ3-11/3 380 V/25 A	11	17-25	496361	71,87
400 VAC 50/60 Hz (Kontrol Gerilimi 220 V AC)	NQ3-5.5P 220 V/1.6A	-	1-1,6	496399	50,94
	NQ3-5.5P 220 V/2.5A	-	1,6-2,5	496403	50,94
	NQ3-5,5P 220 V/4A	-	2,5-4	496405	50,94
	NQ3-5,5 P 220 V/6A	5,5	4-6,0	496406	52,96
	NQ3-5,5 P220 V/8A	5,5	5,5-8	496407	52,96
	NQ3-5,5 P 220 V/10A	5,5	7-10,0	496400	52,96
	NQ3-5,5 P 220 V/13A	5,5	9-13,0	496401	52,96
	NQ3-11/2 220 V/18A	11	12-18,0	496332	71,87
	NQ3-11/3 220 V/25 A	11	17-25	496334	71,87



Bağlantı Şeması

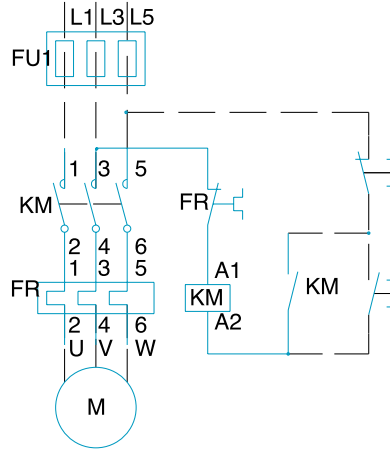

Kontrol beslemesi kaynaktan

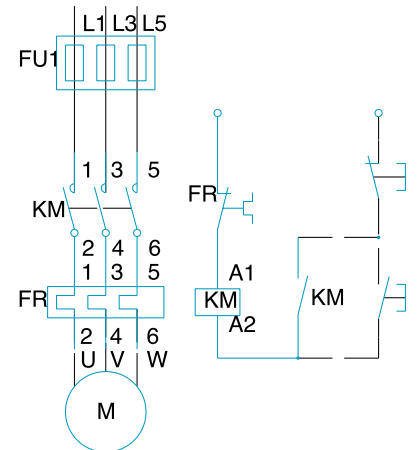

Kontrol beslemesi dışardan

Boyutlar

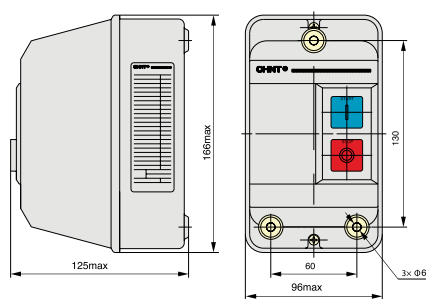

NQ3-5.5P

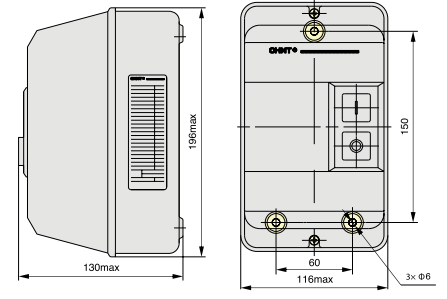

NQ3-11P

NJDC Test Butonlu Endüstriyel Röle

2 Kontaklı 8 Pinli 7.5A

Ürün Tanımı	Sipariş Kodu	Birim Fiyat (€)	Kutu Adeti
NJDC-12/2Z DC12V	651112	8,03	10
NJDC-12/2Z DC24V	651114	8,03	10
NJDC-12/2Z DC110V	651111	8,03	10
NJDC-12/2Z DC220V	651113	8,03	10
NJDC-12/2 AC24V	651109	8,03	10
NJDC-12/2 AC110V	651107	8,03	10
NJDC-12/2 AC220V	651108	8,03	10
NJDC-12/2 AC380V	651110	8,03	10



3 Kontaklı 11 Pinli 7.5A

Ürün Tanımı	Sipariş Kodu	Birim Fiyat (€)	Kutu Adeti
NJDC-12/3Z DC12V	651120	9,18	10
NJDC-12/3Z DC24V	651122	9,18	10
NJDC-12/3Z DC110V	651119	9,18	10
NJDC-12/3Z DC220V	651121	9,18	10
NJDC-12/3 AC24V	651117	9,18	10
NJDC-12/3 AC110V	651115	9,18	10
NJDC-12/3 AC220V	651116	9,18	10

NJDC Endüstriyel Röle ve Soketleri

Yüksek Akım Kapasitesi | 10 A, 8 Bacaklı Test Butonlu



Ürün Tanımı	Sipariş Kodu	Birim Fiyat (€)
JQX-10F 2Z İçin 8 Pinli soket CZF08A	146140	1,51
JQX-10F 2Z İçin 8 Pinli soket CZF08A-E	146141	1,73
JQX-10F 3Z İçin 11 Pinli soket CZF11A	146142	2,10
JQX-10F 3Z İçin 11 Pinli soket CZF11A-E	146143	2,20



CN Serisi Pano İklimlendirme Ekipmanları



Ürün Tanımı	Kontakt	Renk	Sipariş Kodu	Birim Fiyat (€)	Kutu Adeti
CN Serisi Termostat - Soğutma	1NO	Mavi	500500	10,00	10
CN Serisi Termostat- Isıtma	1NK	Kırmızı	500501	10,00	10

EKO Serisi Ø22mm Plastik Seri Butonlar ve Sinyaller

EKO Serisi 22mm LED Sinyal Lambaları



Ürün Tanımı	Nominal Gerilim(V)	Renk	Sipariş Kodu	Birim Fiyat (€)	Kutu Adeti
EKO Serisi 220V AC Sinyal Lambası	220V AC	Kırmızı	500502	2,13	25
EKO Serisi 220V AC Sinyal Lambası	220V AC	Yeşil	500503	2,13	25
EKO Serisi 220V AC Sinyal Lambası	220V AC	Sarı	500504	2,13	25
EKO Serisi 220V AC Sinyal Lambası	220V AC	Mavi	500505	2,13	25
EKO Serisi 220V AC Sinyal Lambası	220V AC	Beyaz	500506	2,13	25
EKO Serisi 220V DC Sinyal Lambası	220V DC	Kırmızı	500507	2,13	25
EKO Serisi 220V DC Sinyal Lambası	220V DC	Yeşil	500508	2,13	25
EKO Serisi 220V DC Sinyal Lambası	220V DC	Sarı	500509	2,13	25
EKO Serisi 220V DC Sinyal Lambası	220V DC	Mavi	500510	2,13	25
EKO Serisi 220V DC Sinyal Lambası	220V DC	Beyaz	500511	2,13	25
EKO Serisi 110V AC/DC Sinyal Lambası	110V AC/DC	Kırmızı	500512	2,13	25
EKO Serisi 110V AC/DC Sinyal Lambası	110V AC/DC	Yeşil	500513	2,13	25
EKO Serisi 110V AC/DC Sinyal Lambası	110V AC/DC	Sarı	500514	2,13	25
EKO Serisi 110V AC/DC Sinyal Lambası	110V AC/DC	Mavi	500515	2,13	25
EKO Serisi 110V AC/DC Sinyal Lambası	110V AC/DC	Beyaz	500516	2,13	25
EKO Serisi 24V AC/DC Sinyal Lambası	24V AC/DC	Kırmızı	500517	2,13	25
EKO Serisi 24V AC/DC Sinyal Lambası	24V AC/DC	Yeşil	500518	2,13	25
EKO Serisi 24V AC/DC Sinyal Lambası	24V AC/DC	Sarı	500519	2,13	25
EKO Serisi 24V AC/DC Sinyal Lambası	24V AC/DC	Mavi	500520	2,13	25
EKO Serisi 24V AC/DC Sinyal Lambası	24V AC/DC	Beyaz	500521	2,13	25

EKO Serisi 22mm Plastik Butonlar



Ürün Tanımı	Kontakt	Renk	Sipariş Kodu	Birim Fiyat (€)	Kutu Adeti
EKO Serisi 1NK Kırmızı Düz Yaylı Buton	1 NK	Kırmızı	500522	2,39	15
EKO Serisi 1NA Yeşil Düz Yaylı Buton	1 NA	Yeşil	500523	2,39	15
EKO Serisi 1NA Sarı Düz Yaylı Buton	1 NA	Sarı	500524	2,39	15
EKO Serisi 1NA Mavi Düz Yaylı Buton	1 NA	Mavi	500525	2,39	15
EKO Serisi 1NA Beyaz Düz Yaylı Buton	1 NA	Beyaz	500526	2,39	15
EKO Serisi 1NA Siyah Düz Yaylı Buton	1 NA	Siyah	500527	2,39	15

*Not: Kırmızı renk dışında NK kontaklı butonlarımız da mevcuttur. Sipariş için lütfen sorunuz.

**Not: 1NA+1NK kontak kombinasyonlu butonlarımız da mevcuttur. Sipariş için lütfen sorunuz.



EKO Serisi 22mm İkiz Butonlar

Ürün Tanımı	Kontakt	Renk	Sipariş Kodu	Birim Fiyat (€)	Kutu Adeti
EKO Serisi 1NA+1NK İkiz Yaylı Buton	1NA+1NK	Kırmızı-Yeşil	500535	4,15	10



EKO Serisi 22mm Plastik Acil Stop Butonu

Ürün Tanımı	Kontakt	Renk	Sipariş Kodu	Birim Fiyat (€)	Kutu Adeti
EKO Serisi 40mm 1NK Kırmızı Acil Stop Butonu	1 NK	Kırmızı	500528	3,71	10



EKO Serisi 22mm Plastik Mandal Butonlar

Ürün Tanımı	Kontakt	Pozisyon	Sipariş Kodu	Birim Fiyat (€)	Kutu Adeti
EKO Serisi 1NA Kalıcı 0-1 Mandal Buton	1 NA		500529	2,67	12
EKO Serisi 2NA Kalıcı 1-0-2 Mandal Buton	2 NA		500530	3,76	12
EKO Serisi 1NA Yay Dönüştürücü 0-1 Mandal Buton	1 NA		500531	2,92	12
EKO Serisi 2NA Yay Dönüştürücü 1-0-2 Mandal Buton	2 NA		500532	4,45	12



EKO Serisi İlave Kontakt Bloklar

Ürün Tanımı	Kontakt	Sipariş Kodu	Birim Fiyat (€)	Kutu Adeti
EKO Serisi 1NK İlave Kontakt Blok	1 NK	500533	1,24	50
EKO Serisi 1NA İlave Kontakt Blok	1 NA	500534	1,24	50

ND16 Plastik Seri Sinyal Lambası

IEC IEC/EN60947-5-1



Ürün Tanımı	24/230 V AC	Renk	Sipariş Kodu	Birim Fiyat (€)	Kutu Adeti
Açılı Kafalı Kısa Gövde 1NA	22DS/2 24V	Beyaz	592936	2,65	10
		Turuncu	593154	2,65	10
		Kırmızı	592938	2,65	10
		Sarı	592939	2,65	10
		Mavi	592937	2,65	10
		Yeşil	592940	2,65	10
Açılı Kafalı Kısa Gövde 1NA	22DS/4 220V	Kırmızı	592718	2,65	10
		Sarı	592719	2,65	10
		Yeşil	592720	2,65	10













Buzzer

Ürün Tanımı	Sipariş Kodu	Birim Fiyat (€)	Kutu Adeti
ND-16F Kırmızı 22mm Kesintili Çalışmalı 230V AC	593391	4,99	10
ND-16F Kırmızı 22mm Kesintili Çalışmalı 24 V AC/DC	593381	4,99	10



NP2 Serisi 22mm Metal Seri Buton ve Sinyal Lambası

IEC IEC/EN60947-5-1

	Ürün Tanımı 220/380 V AC	Kontakt	Renk	Sipariş Kodu	Birim Fiyat (€)	Kutu Adeti
	Yaylı Buton	1NA	Beyaz	573954	2,99	10
		1NA	Siyah	573955	2,99	10
		1NA	Yeşil	573956	2,99	10
		1NA	Sarı	573959	2,99	10
		1NA	Mavi	573892	2,99	10
		1NK	Kırmızı	573890	2,99	10
	40mm Mantar	1NA	Siyah	573969	4,50	10
	Acil Stop Butonu 40 mm	1NK	Kırmızı	573894	4,93	10
	İkiz Buton	Start/Stop	1NA+1NK	Yeşil+Kırmızı	574004	5,31
		Start/Stop/Işıklı LED'li 24 V	1NA+1NK	Yeşil+Kırmızı	574368	8,71
		Start/Stop/Işıklı LED'li 220V	1NA+1NK	Yeşil+Kırmızı	574909	8,71
	Işıklı yaylı Buton, LED'li 24 VAC	1NA+1NK	Beyaz	574337	6,24	10
		1NA+1NK	Yeşil	574340	6,24	10
		1NA+1NK	Kırmızı	574343	6,24	10
		1NA+1NK	Sarı	574346	6,24	10
		1NA+1NK	Mavi	574349	6,24	10
	Işıklı Yaylı Buton, LED'li 220 V AC/DC	1NA+1NK	Beyaz	574364	6,24	10
		1NA+1NK	Yeşil	575642	6,24	10
		1NA+1NK	Kırmızı	575643	6,24	10
		1NA+1NK	Sarı	575647	6,24	10
		1NA+1NK	Mavi	574367	6,24	10
	Plastik Korumalı, Yaylı Buton	1NA	Siyah	575875	3,35	10
		1NA	Yeşil	575876	3,35	10
		1NA	Sarı	575877	3,35	10
		1NK	Kırmızı	575878	3,35	10
	Mandal Buton	2 Konum Kalıcı	1NA	Siyah	573977	3,51
		3 Konum Kalıcı	1NA+1NK	Siyah	574658	4,69
		3 Konum geriye Yaylı	1NA+1NK	Siyah	574659	5,07
	Uzun Mandal Buton	2 Konum Kalıcı	1NA	Siyah	573992	3,51
		3 Konum Kalıcı	1NA+1NK	Siyah	574209	4,93
		3 Konum geriye Yaylı	1NA+1NK	Siyah	574653	5,31
	Kilit Buton	2 Konumlu	1NA	Siyah	573986	6,06
		3 Konumlu, Kilit Her Yönde	1NA+1NK	Siyah	574657	7,58
		3 Konumlu, Kilit Ortada	1NA+1NK	Siyah	574654	7,58
	Sinyal lambası, LED'li 220 V AC/DC		Beyaz	574386	3,89	10
			Yeşil	574048	3,89	10
			Kırmızı	574049	3,89	10
			Sarı	574050	3,89	10
			Mavi	575623	3,89	10
	Sinyal Lambası, LED'li 24 V AC/DC		Beyaz	574331	3,89	10
			Yeşil	574045	3,89	10
			Kırmızı	574046	3,89	10
			Sarı	574047	3,89	10
			Mavi	575218	3,89	10



NP2 Serisi 22mm Plastik Seri Buton ve Sinyal Lambası

IEC IEC/EN60947-5-1

	Ürün Tanımı 220/380 V AC	Kontak	Renk	Sipariş Kodu	Birim Fiyat (€)	Kutu Adeti
	Yaylı Buton	1NA	Beyaz	574576	2,80	10
		1NA	Siyah	574084	2,80	10
		1NA	Yeşil	574085	2,80	10
		1NA	Sarı	574086	2,80	10
		1NA	Mavi	574087	2,80	10
		1NK	Kırmızı	574089	2,80	10
		40mm Mantar	1NK	Siyah	574092	4,50
	Acil Stop Butonu 40 mm	1NK	Kırmızı	574120	4,50	10
	İkiz Buton	Start/Stop	1NA+1NK	Yeşil+Kırmızı	575281	4,70
		Start/Stop/Işıklı LED'li 24 V	1NA+1NK	Yeşil+Kırmızı	575439	6,82
		Start/Stop/Işıklı LED'li 220V	1NA+1NK	Yeşil+Kırmızı	575343	6,82
	Işıklı yaylı Buton, LED'li 24 VAC/DC	1NA+1NK	Beyaz	575306	5,50	10
		1NA+1NK	Yeşil	575316	5,50	10
		1NA+1NK	Kırmızı	575330	5,50	10
		1NA+1NK	Sarı	575336	5,50	10
		1NA+1NK	Mavi	575342	5,50	10
	Işıklı Yaylı Buton, LED'li 220 V AC/DC	1NA+1NK	Beyaz	575644	5,50	10
		1NA+1NK	Yeşil	574164	5,50	10
		1NA+1NK	Kırmızı	575645	5,50	10
		1NA+1NK	Sarı	574163	5,50	10
		1NA+1NK	Mavi	575447	5,50	10
	Mandal Buton	2 Konum Kalıcı	1NA	Siyah	574095	3,20
		3 Konum Kalıcı	1NA+1NK	Siyah	575423	4,30
		3 Konum geriye Yaylı	1NA+1NK	Siyah	575558	4,90
	Uzun Mandal Buton	2 Konum Kalıcı	1NA	Siyah	574108	3,20
		3 Konum Kalıcı	1NA+1NK	Siyah	575424	4,30
		3 Konum geriye Yaylı	1NA+1NK	Siyah	576025	4,90
	Kilit Buton	2 Konumlu	1NA	Siyah	574102	4,93
		3 Konumlu, Kilit her Yönde.	1NA+1NK	Siyah	575964	6,06
		3 Konumlu, Kilit Ortada	1NA+1NK	Siyah	576027	6,06
	Sinyal lambası, LED'li 220 V AC/DC		Beyaz	574798	3,13	10
			Yeşil	574582	3,13	10
			Kırmızı	574583	3,13	10
			Sarı	574668	3,13	10
			Mavi	574683	3,13	10
	Sinyal Lambası, LED'li 24 V AC/DC		Beyaz	575296	3,13	10
			Yeşil	574629	3,13	10
			Kırmızı	574142	3,13	10
			Sarı	575299	3,13	10
			Mavi	575300	3,13	10

NP2 Serisi Butonlar için Yardımcı Aksesuarlar

Ürün Tanımı 220/380 V AC	Kontak	Renk	Sipariş Kodu	Birim Fiyat (€)	Kutu Adeti
İlave Kontak	1NA		576841	1,89	50
İlave Kontak	1NK		576842	1,89	50
Pano Etiketi			576794	0,38	80
Sarı Renk Dairesel Etiket (Acil Durdurma)			576785	0,65	80



NP8 Serisi 22mm Krom Gövde Seri Buton ve Sinyal Lambası

IEC IEC/EN60947-5-1

	Ürün Tanımı 220/380 V AC	Kontakt	Renk	Sipariş Kodu	Birim Fiyat (€)	Kutu Adeti
		1NA	Beyaz	578646	4,54	10
		1NA	Siyah	578647	4,54	10
		1NA	Yeşil	667232	4,54	10
		1NA	Sarı	667333	4,54	10
		1NA	Mavi	578645	4,54	10
		1NK	Kırmızı	667231	4,54	10
	40mm Mantar	1NA	Siyah	578935	5,68	10
	Acil Stop Butonu 40 mm	1NK	Kırmızı	667210	6,82	10
	Start/Stop	1NA+1NK	Yeşil+Kırmızı	667178	7,58	10
	Start/Stop/Işıklı LED'li 24 VAC/DC & 220 VAC	1NA+1NK	Yeşil+Kırmızı	667173	15,94	10
	Işıklı Yaylı Buton, LED'li 24 VAC/ DC & 220 VAC	1NA	Beyaz	578662	9,47	10
		1NA	Yeşil	667251	9,47	10
		1NA	Kırmızı	667252	9,47	10
		1NA	Sarı	667321	9,47	10
		1NA	Mavi	578663	9,47	
	2 Konum Kalıcı	1NA	Siyah	578661	6,06	10
	3 Konum Kalıcı	1NA+1NK	Siyah	667137	8,71	10
	Işıklı Mandal Buton, 2 Konum Kalıcı 24VAC/DC & 220VAC	1NA+1NK	Yeşil	667149	14,05	10
		1NA+1NK	Kırmızı	667150	14,05	10
		1NA+1NK	Sarı	667151	14,05	10
	Işıklı Mandal Buton, 3 Konum Kalıcı 24VAC/DC & 220VAC	1NA+1NK	Yeşil	667161	15,18	10
		1NA+1NK	Kırmızı	667162	15,18	10
		1NA+1NK	Sarı	667163	15,18	10
	2 Konumlu	1NA		578130	6,45	10
	3 Konumlu, Kilit her Yönde.	1NA+1NK		667183	9,86	10
	Sinyal Lambası, LED'li 24 VAC/ DC & 220 VAC		Beyaz	578991	8,71	10
			Yeşil	667107	8,71	10
			Kırmızı	667108	8,71	10
			Sarı	578651	8,71	10
			Mavi	578642	8,71	10













Siparişte Sinyal Lambası Gerilim Seviyesi mutlaka bildirilmelidir.













24V, 48V, 110V, 220V AC
24V, 48V, 110V, 220V DC

NP2 Kutular

Esnek Çözüm

IEC IEC/EN60947-5-1

Sipariş Kodu	Birim Fiyat (€)
 573891	5,40
 575576	7,33
 575577	8,88
 575575	8,88
 573927	11,58
 573928	11,58
 573929	11,58
 573930	11,58
 573931	11,58
 573933	11,58
 574878	13,15
 573937	13,15
 573936	13,15

Sipariş Kodu	Birim Fiyat (€)
 574165	13,15
 574166	13,15
 573938	16,24
 573939	16,24
 573940	16,24
 573941	19,93
 573945	19,93
 573946	19,93
 573947	19,93
 573949	19,93
 573944	19,93
 573950	19,93



Zaman Röleleri | Elektronik | DIN Ray Tip



Ürün Tanımı	Zaman Aralığı	Uygulama		Teknik Özellikler								Çalışma Gerilimi			Sipariş Kodu	Birim Fiyat (€)	
		Kademe Sayısı	Ray Tipi / İnce (22,5)	Çekmede Gecikmeli (Delay ON)	Bırakmada Gecikmeli (Delay OFF)	Çift Zaman Ayarı	Yıldız - Üçgen	Simetrik Flaşör	Tetiklemeli	Açık Flaşör (ON)	Kapalı Flaşör (OFF)	24 V AC/DC	220V AC	Universal 24-220 VAC/DC			12 VAC/DC
DN-T01 Zaman Rölesi	0,1 - 30 sn		●	●	●											500308	16,70
DN-T02 Zaman Rölesi	0,1 sn - 60 sn		●	●	●	●										500309	16,70
DN-T03 Çok Fonksiyonlu Zaman Rölesi	0,06 sn - 30 saat	7	●	●	●	●					●	●	●	●		500310	20,94
DN-T04 Çok Fonksiyonlu Zaman Rölesi	0,6 sn - 10 saat	6	●						●		●	●	●			500311	20,94
DN-T05 Çok Fonksiyonlu Zaman Rölesi	0,05 - 100 saat	7	●	●	●					●	●	●		●		500312	24,06
DN-SD Yıldız-Üçgen Rölesi	Y: 3 sec -30 sec Y→ Δ:50...500msec.		●						●	●				●		500313	33,09

Gerilim Koruma Röleleri | Elektronik | DIN Ray Tip



Ürün Tanımı	Uygulama		Teknik Özellikler										Çalışma Gerilimi	Sipariş Kodu	Birim Fiyat (€)
	Ray Tipi / İnce (22,5)	Ray Tipi / Normal (35)	Led Göstergeli Ekran	Tek Faz	3 Faz	Aşırı Gerilim Ani Açma (Un*1,5)	Düşük Gerilim Ani Açma (Un*0,5)	Faz Sırası	Faz Yokluğu	Çekme Gecikmesi (t-on)	Açma/Bırakma Gecikmesi (t-off)	220 Vac ± %35			
DN-VP01 Gerilim Koruma Rölesi		●	●	●		●	●		●	X (1 sn. - 20 sn.)	X (1 sn. - 20 sn.)	●	500314	24,67	
DN-VP02 Gerilim Koruma Rölesi	●		●	●		●	●		●		X (1 sn. - 20 sn.)	●	500315	24,67	
DN-VP03 Gerilim Koruma Rölesi	●		●		●	●	●	●			X (1 sn. - 20 sn.)	●	500316	24,67	
DN-VP04 Gerilim Koruma Rölesi	●		●	●		●	●		●	X (3 dk.)	X (0,1 sn. - 20 sn.)	●	500317	24,67	
DN-VP05 Gerilim Koruma Rölesi	●		●	●		●	●	●	●	X (3 dk.)	X (0,1 sn. - 20 sn.)	●	500318	24,67	

Motor (Faz) Koruma Röleleri | Elektronik | DIN Ray Tip



Ürün Tanımı	Uygulama		Ölçüm ve Teknik Özellikler							Besleme	Sipariş Kodu	Birim Fiyat (€)
	Ray Tipi / İnce (22,5)	Manuel Gösterge Ekran	Nötr Kopması Algılaması	Faz Sırası Korumalı	Asimetri Ayarlı	Asimetre Aralığı	Faz - Faz	Faz - Nötr	Açma/Bırakma Gecikmesi (t-off)			
DN-MP01 Motor (Faz) Koruma Rölesi	●	●	●			30%		●		●	500319	19,19
DN-MP02 Motor (Faz) Koruma Rölesi	●	●	●	●	●	%5 - %15	●		X (0,1 sn. - 10 sn.)	●	500320	24,67
DN-M03 Motor(Faz) Koruma Rölesi	●	●				30%		●		●	500392	17,12
DN-M04 Motor(Faz) Koruma Rölesi	●	●		●	●	%10 - %30		●		●	500552	20,45

Hidrofor Sıralama Rölesi | Elektronik | DIN Ray Tip



	Uygulama		Ölçüm ve Teknik Özellikler		Kutu Adeti	Sipariş Kodu	Birim Fiyat (€)
	Ray Tipi /Ince /Ince (22,5)		2 Basınç Şalter Girişi	2 Hidrofor Çıkışı			
DN-H01 Hidrofor Sıralama Rölesi	●		●	●	10	500401	32,49

Fotosel Rölesi | Elektronik | DIN Ray Tip



	Uygulama		Ölçüm ve Teknik Özellikler			Kutu Adeti	Sipariş Kodu	Birim Fiyat (€)
	Ray Tipi /Ince /Ince (22,5)		1-10 Lux Ayarlı	Röle Çıkışı	Fotosel Göz Dahil			
DN-F01 Fotosel Rölesi	●		●	●	●	10	500536	27,07

Sıvı Seviye Kontrol Röleleri | Elektronik | DIN Ray Tip



Ürün Tanımı	Uygulama		Ölçüm ve Teknik Özellikler			Besleme	Sipariş Kodu	Birim Fiyat (€)
	Ray Tipi /Ince (22,5)	Led Göstergeli	2-100 kΩ İletkenlik Ayarı	Boy: 150 mm Ø: 26 mm	Boy: 90 mm Ø: 19 mm			
DN-L01 Sıvı Seviye Kontrol Rölesi	●	●	●			220 VAC ±%20 (L-N)	500321	22,56
SE-L01 Küçük Elektrod					●		500322	3,25
BE-L01 Büyük Elektrod				●			500323	4,27

CDM Serisi Dijital Multimetreler



Ürün Tanımı	Boyutlar	Uygulama ve Teknik Özellikler									Besleme	Sipariş Kodu	Birim Fiyat (€)
	96x96mm	İzole	Uygulama Alçak Gerilim	LED EKРАН	3 * Voltmetre	3* Ampermetre	3* Frekansmetre	Hz	TRUE RMS	SINIF (CLASS)	Besleme Gerilimi		
CDM-01 Dijital Multimetre	●		●	●	●	●	●	●	●	0,5	220 Vac ± %20	500537	77,00
CDM-02 İzoleli Dijital Multimetre	●	●	●	●	●	●	●	●	●	0,5	220 Vac ± %20	500538	90,23



CDM-04 Serisi Enerji Analizörü



Ürün Tanımı	Boyut	Uygulama ve Teknik Özellikler														Sipariş Kodu	Birim Fiyat (€)				
		3* Gerilim (Faz-Nötr)	3* Gerilim (Faz-Faz)	3* Akım(A)	3* Frekans(Hz)	COSΦ	Görünür Güç(KVA)	Aktif Güç (W)	Reaktif Güç (VAR)	Σ VA	Σ W	Σ VAR	kWh	kVarLh	kVarCh			% THD I (33)	%THD V(33)	RS-232	RS-485
CDM-04 Serisi Enerji Analizörü	96x96	●	●	●	●	●	●	●	●	●	●	●	●	●	●	●	●	●	●	500771	177,47



CDM-03 Serisi Enerji Güç Ölçer



Ürün Tanımı	Boyut	Uygulama ve Teknik Özellikler						Sipariş Kodu	Birim Fiyat (€)
		3* Gerilim (Faz-Nötr)	3* Gerilim (Faz-Faz)	3* Akım(A)	3* Frekans(Hz)	COSΦ	Aktif Güç(W)		
CDM-03 Serisi Enerji Güç Ölçer	96x96	●	●	●	●	●	●	500770	110,92



Dijital Voltmetre ve Ampermetreler



Ürün Tanımı	Ölçüm Aralığı	Ölçüm Tipi	Boyut(mm)	Sipariş Kodu	Birim Fiyat (€)
EAM72 Serisi Dijital Ampermetre	0 ... 9999 A	AC	72x72	500625	38,60
EAM96 Serisi Dijital Ampermetre	0 ... 9999 A	AC	96x96	500626	41,26
EVM72 Serisi Dijital Voltmetre	5 ... 500 V	AC	72x72	500627	38,60
EVM96 Serisi Dijital Voltmetre	5 ... 500 V	AC	96x96	500628	41,26
EVM72-3F Serisi 3 Faz Dijital Voltmetre	L1: 180V...260V L2: 5...300V L3: 5...300V	AC	72x72	500772	54,07

0-1 Aç/Kapa Pako Şalterler

Kod Detayı				
Ürün serisi	Kutup sayısı	Akım	Tip	Model
CSL	*P	***A	01: Aç/kapa tip 02: 1-0-2 kutup değiştirici tip	S : Emniyet- sarı kırmızı kilitle çerçeve Boş: -
Ürün Tanımı	Faz/Kutup Sayısı	Nominal Akım(A)	Sipariş Kodu	Birim Fiyat (€)
CSL-1P010A01	1	10	500370	5,75
CSL-1P016A01	1	16	500371	6,31
CSL-1P025A01	1	25	500372	9,25
CSL-1P032A01	1	32	500847	13,06
CSL-1P040A01	1	40	500373	14,05
CSL-1P063A01	1	63	500374	16,88
CSL-1P080A01	1	80	500375	22,17
CSL-1P100A01	1	100	500848	23,92
CSL-2P010A01	2	10	500376	7,76
CSL-2P016A01	2	16	500377	9,49
CSL-2P025A01	2	25	500378	12,77
CSL-2P032A01	2	32	500849	16,76
CSL-2P040A01	2	40	500379	17,10
CSL-2P063A01	2	63	500380	21,81
CSL-2P080A01	2	80	500381	29,57
CSL-2P100A01	2	100	500850	32,15
CSL-3P010A01	3	10	500382	9,49
CSL-3P016A01	3	16	500383	11,58
CSL-3P025A01	3	25	500384	15,43
CSL-3P032A01	3	32	500851	20,33
CSL-3P040A01	3	40	500385	23,04
CSL-3P063A01	3	63	500386	30,40
CSL-3P080A01	3	80	500132	36,96
CSL-3P100A01	3	100	500852	38,09
CSL-4P010A01	4	10	500133	12,45
CSL-4P016A01	4	16	500134	14,29
CSL-4P025A01	4	25	500135	18,23
CSL-4P032A01	4	32	500853	25,01
CSL-4P040A01	4	40	500136	25,77
CSL-4P063A01	4	63	500137	35,48
CSL-4P080A01	4	80	500138	45,70
CSL-4P100A01	4	100	500854	48,27
CSL-5P010A01	5	10	500139	18,50
CSL-5P016A01	5	16	500140	18,60
CSL-5P025A01	5	25	500141	22,33
CSL-5P032A01	5	32	500855	30,86
CSL-5P040A01	5	40	500142	33,98
CSL-5P063A01	5	63	500143	40,82
CSL-5P080A01	5	80	500144	49,58
CSL-5P100A01	5	100	500856	61,39
CSL-6P010A01	6	10	500145	19,64
CSL-6P016A01	6	16	500146	20,20
CSL-6P025A01	6	25	500147	22,75
CSL-6P032A01	6	32	500857	32,29
CSL-6P040A01	6	40	500148	36,40
CSL-6P063A01	6	63	500149	43,32
CSL-6P080A01	6	80	500150	63,47
CSL-6P100A01	6	100	500858	73,39

* 80A ve üzeri talepleriniz için üretim yapılabilir. * Her tip pako şalter için uygun kutu mevcuttur.

Emniyet Tip Aç-Kapa Pako Şalterler



Ürün Tanımı	Faz/Kutup Sayısı	Nominal Akım (A)	Sipariş Kodu	Birim Fiyat (€)
CSL-1P010A01S	1	10	500151	5,75
CSL-1P016A01S	1	16	500152	6,31
CSL-1P025A01S	1	25	500153	9,25
CSL-1P032A01S	1	32	500859	13,06
CSL-1P040A01S	1	40	500154	14,05
CSL-1P063A01S	1	63	500155	16,88
CSL-1P080A01S	1	80	500156	22,17
CSL-1P100A01S	1	100	500860	23,92
CSL-2P010A01S	2	10	500157	7,76
CSL-2P016A01S	2	16	500158	9,49
CSL-2P025A01S	2	25	500159	12,77
CSL-2P032A01S	2	32	500861	16,76
CSL-2P040A01S	2	40	500160	17,10
CSL-2P063A01S	2	63	500161	21,81
CSL-2P080A01S	2	80	500162	29,57
CSL-2P100A01S	2	100	500862	32,15
CSL-3P010A01S	3	10	500163	9,49
CSL-3P016A01S	3	16	500164	11,58
CSL-3P025A01S	3	25	500165	15,43
CSL-3P032A01S	3	32	500863	20,33
CSL-3P040A01S	3	40	500166	23,04
CSL-3P063A01S	3	63	500167	30,40
CSL-3P080A01S	3	80	500168	36,96
CSL-3P100A01S	3	100	500864	38,09
CSL-4P010A01S	4	10	500169	12,45
CSL-4P016A01S	4	16	500170	14,29
CSL-4P025A01S	4	25	500171	18,23
CSL-4P032A01S	4	32	500865	25,01
CSL-4P040A01S	4	40	500172	25,77
CSL-4P063A01S	4	63	500173	35,48
CSL-4P080A01S	4	80	500174	45,70
CSL-4P100A01S	4	100	500866	48,27
CSL-5P010A01S	5	10	500175	18,50
CSL-5P016A01S	5	16	500176	18,60
CSL-5P025A01S	5	25	500177	22,33
CSL-5P032A01S	5	32	500867	30,86
CSL-5P040A01S	5	40	500178	33,98
CSL-5P063A01S	5	63	500179	40,82
CSL-5P080A01S	5	80	500180	49,58
CSL-5P100A01S	5	100	500868	61,39
CSL-6P010A01S	6	10	500305	19,64
CSL-6P016A01S	6	16	500306	20,20
CSL-6P025A01S	6	25	500307	22,75
CSL-6P032A01S	6	32	500869	32,29
CSL-6P040A01S	6	40	500181	36,40
CSL-6P063A01S	6	63	500182	43,32
CSL-6P080A01S	6	80	500183	63,47
CSL-6P100A01S	6	100	500870	73,39

* 80A ve üzeri talepleriniz için üretim yapılabilir.

* Her tip pako şalter için uygun kutu mevcuttur.

1 - 0 - 2 Kademeli / Kutup Değişirici Pako Şalterler



Ürün Tanımı	Faz/Kutup Sayısı	Nominal Akım(A)	Sipariş Kodu	Birim Fiyat (€)
CSL-1P010A02	1	10	500184	8,53
CSL-1P016A02	1	16	500185	8,87
CSL-1P025A02	1	25	500186	13,45
CSL-1P032A02	1	32	500187	16,71
CSL-1P040A02	1	40	500188	18,48
CSL-1P063A02	1	63	500189	23,48
CSL-1P080A02	1	80	500190	36,50
CSL-1P100A02	1	100	500871	40,06
CSL-2P010A02	2	10	500191	12,94
CSL-2P016A02	2	16	500192	14,05
CSL-2P025A02	2	25	500193	18,68
CSL-2P032A02	2	32	500872	24,27
CSL-2P040A02	2	40	500194	27,55
CSL-2P063A02	2	63	500195	34,99
CSL-2P080A02	2	80	500196	54,57
CSL-2P100A02	2	100	500873	58,14
CSL-3P010A02	3	10	500197	14,19
CSL-3P016A02	3	16	500198	16,21
CSL-3P025A02	3	25	500199	26,07
CSL-3P032A02	3	32	500200	33,01
CSL-3P040A02	3	40	500201	37,30
CSL-3P063A02	3	63	500202	48,73
CSL-3P080A02	3	80	500874	68,93
CSL-3P100A02	3	100	500875	73,04

* İstenildiği takdirde diğer Amper talepli kutup değiştiriciler de üretilebilir.

* İstenildiği takdirde "1 - 2" kademeli şalterlerde üretilebilir.

* Her tip pako şalter için uygun kutu mevcuttur.

CSL Serisi Kademeli Şalterler



Ürün Tanımı	Faz/Kutup Sayısı	Pozisyon	Nominal Akım(A)	Sipariş Kodu	Birim Fiyat (€)
CSL-1P010A032	1	0-1-2	10	500456	10,20
CSL-1P016A032	1	0-1-2	16	500457	10,35
CSL-1P025A032	1	0-1-2	25	500459	13,01
CSL-1P040A032	1	0-1-2	40	500460	17,58
CSL-1P063A032	1	0-1-2	63	500461	28,56
CSL-1P080A032	1	0-1-2	80	500462	33,72
CSL-1P010A033	1	0-1-2-3	10	500388	11,70
CSL-1P016A033	1	0-1-2-3	16	500463	12,92
CSL-1P025A033	1	0-1-2-3	25	500465	17,23
CSL-1P040A033	1	0-1-2-3	40	500466	22,67
CSL-1P063A033	1	0-1-2-3	63	500467	33,01
CSL-1P080A033	1	0-1-2-3	80	500468	41,39
CSL-1P010A034	1	0-1-2-3-4	10	500389	13,09
CSL-1P016A034	1	0-1-2-3-4	16	500469	15,14
CSL-1P025A034	1	0-1-2-3-4	25	500471	19,42
CSL-1P040A034	1	0-1-2-3-4	40	500472	28,41
CSL-1P063A034	1	0-1-2-3-4	63	500473	36,93
CSL-1P080A034	1	0-1-2-3-4	80	500474	43,44
CSL-1P010A035	1	0-1-2-3-4-5	10	500390	16,26
CSL-1P016A035	1	0-1-2-3-4-5	16	500475	17,00
CSL-1P025A035	1	0-1-2-3-4-5	25	500477	24,76
CSL-1P040A035	1	0-1-2-3-4-5	40	500478	33,26
CSL-1P063A035	1	0-1-2-3-4-5	63	500479	44,30
CSL-1P080A035	1	0-1-2-3-4-5	80	500480	48,83
CSL-1P010A036	1	0-1-2-3-4-5-6	10	500391	18,68
CSL-1P016A036	1	0-1-2-3-4-5-6	16	500482	18,92
CSL-1P025A036	1	0-1-2-3-4-5-6	25	500484	27,14
CSL-1P040A036	1	0-1-2-3-4-5-6	40	500485	38,56
CSL-1P063A036	1	0-1-2-3-4-5-6	63	500486	52,33
CSL-1P080A036	1	0-1-2-3-4-5-6	80	500487	69,35
CSL-1P010A037	1	0-1-2-3-4-5-6-7	10	500488	20,40
CSL-1P016A037	1	0-1-2-3-4-5-6-7	16	500489	20,75
CSL-1P025A037	1	0-1-2-3-4-5-6-7	25	500491	30,94
CSL-1P040A037	1	0-1-2-3-4-5-6-7	40	500492	41,02
CSL-1P063A037	1	0-1-2-3-4-5-6-7	63	500493	57,65
CSL-1P080A037	1	0-1-2-3-4-5-6-7	80	500494	80,31



CSL Serisi 7 Pozisyon Voltmetre Şalteri



Ürün Tanımı	Faz/Kutup Sayısı	Pozisyon	Nominal Akım(A)	Sipariş Kodu	Birim Fiyat (€)
CSL-3P010A07V	3	0-L1N-L2N-L3N-L1L2-L2L3-L1L3	10	500395	16,46
CSL-3P016A07V	3	0-L1N-L2N-L3N-L1L2-L2L3-L1L3	16	500495	17,21
CSL-3P020A07V	3	0-L1N-L2N-L3N-L1L2-L2L3-L1L3	20	500496	19,79

CSX Serisi 0-1 Aç/Kapa Pako Şalterler

Kod Detayı				
Ürün serisi	Kutup sayısı	Akım	Tip	Model
CSX	*P	***A	01: Aç/kapa tip 02: 1-0-2 kutup değiştirici tip	M:- TR:- SM:Emniyet- sarı kırmızı kilitle çerçeve STR:Emniyet- sarı kırmızı kilitle çerçeve

Ürün Tanımı	Faz/Kutup Sayısı	Nominal Akım(A)	Sipariş Kodu	Birim Fiyat (€)
CSX-1P010A01M	1	10	500203	6,58
CSX-1P016A01M	1	16	500204	6,83
CSX-1P020A01M	1	20	500205	7,08
CSX-1P025A01M	1	25	500206	9,68
CSX-1P040A01M	1	32/40	500207	16,14
CSX-1P063A01TR	1	63	500208	17,62
CSX-1P080A01TR	1	80	500209	18,62
CSX-2P010A01M	2	10	500210	8,13
CSX-2P016A01M	2	16	500211	8,44
CSX-2P020A01M	2	20	500212	9,31
CSX-2P025A01M	2	25	500213	11,17
CSX-2P040A01M	2	32/40	500214	23,08
CSX-2P063A01TR	2	63	500215	24,45
CSX-2P080A01TR	2	80	500216	27,30
CSX-3P010A01M	3	10	500217	10,55
CSX-3P016A01M	3	16	500218	11,17
CSX-3P020A01M	3	20	500219	12,04
CSX-3P025A01M	3	25	500220	14,65
CSX-3P040A01M	3	32/40	500221	31,89
CSX-3P063A01TR	3	63	500222	33,17
CSX-3P080A01TR	3	80	500223	40,33
CSX-4P010A01M	4	10	500224	13,03
CSX-4P016A01M	4	16	500225	13,28
CSX-4P020A01M	4	20	500226	13,90
CSX-4P025A01M	4	25	500227	23,58
CSX-4P040A01M	4	32/40	500228	38,47
CSX-4P063A01TR	4	63	500229	40,95
CSX-4P080A01TR	4	80	500230	47,78
CSX-5P010A01M	5	10	500231	15,42
CSX-5P016A01M	5	16	500232	16,07
CSX-5P020A01M	5	20	500233	16,76
CSX-5P025A01M	5	25	500234	17,75
CSX-5P040A01M	5	32/40	500235	48,40
CSX-5P063A01TR	5	63	500236	51,13
CSX-5P080A01TR	5	80	500237	59,56
CSX-6P010A01M	6	10	500238	22,34
CSX-6P016A01M	6	16	500239	23,58
CSX-6P020A01M	6	20	500240	24,20
CSX-6P025A01M	6	25	500241	24,95
CSX-6P040A01M	6	32/40	500242	54,60
CSX-6P063A01TR	6	63	500243	57,45
CSX-6P080A01TR	6	80	500244	68,25



Emniyet Tip Aç-Kapa Pako Şalterler



Ürün Tanımı	Faz/Kutup Sayısı	Nominal Akım(A)	Sipariş Kodu	Birim Fiyat (€)
CSX-1P010A01SM	1	10	500245	6,58
CSX-1P016A01SM	1	16	500246	6,83
CSX-1P020A01SM	1	20	500247	7,08
CSX-1P025A01SM	1	25	500248	9,68
CSX-1P040A01SM	1	32/40	500249	16,14
CSX-1P063A01STR	1	63	500250	17,62
CSX-1P080A01STR	1	80	500251	18,62
CSX-2P010A01SM	2	10	500252	8,13
CSX-2P016A01SM	2	16	500253	8,44
CSX-2P020A01SM	2	20	500254	9,31
CSX-2P025A01SM	2	25	500255	11,17
CSX-2P040A01SM	2	32/40	500256	23,08
CSX-2P063A01STR	2	63	500257	24,45
CSX-2P080A01STR	2	80	500258	27,30
CSX-3P010A01SM	3	10	500259	10,55
CSX-3P016A01SM	3	16	500260	11,17
CSX-3P020A01SM	3	20	500261	12,04
CSX-3P025A01SM	3	25	500262	14,65
CSX-3P040A01SM	3	32/40	500263	31,89
CSX-3P063A01STR	3	63	500264	33,17
CSX-3P080A01STR	3	80	500265	40,33
CSX-4P010A01SM	4	10	500266	13,03
CSX-4P016A01SM	4	16	500267	13,28
CSX-4P020A01SM	4	20	500268	13,90
CSX-4P025A01SM	4	25	500269	23,58
CSX-4P040A01SM	4	32/40	500270	38,47
CSX-4P063A01STR	4	63	500271	40,95
CSX-4P080A01STR	4	80	500272	47,78
CSX-5P010A01SM	5	10	500273	15,42
CSX-5P016A01SM	5	16	500274	16,07
CSX-5P020A01SM	5	20	500275	16,76
CSX-5P025A01SM	5	25	500276	17,75
CSX-5P040A01SM	5	32/40	500277	48,40
CSX-5P063A01STR	5	63	500278	51,13
CSX-5P080A01STR	5	80	500279	59,56
CSX-6P010A01SM	6	10	500280	22,34
CSX-6P016A01SM	6	16	500281	23,58
CSX-6P020A01SM	6	20	500282	24,20
CSX-6P025A01SM	6	25	500283	24,95
CSX-6P040A01SM	6	32/40	500284	54,60
CSX-6P063A01STR	6	63	500285	57,45
CSX-6P080A01STR	6	80	500286	68,25

* 80A ve üzeri talepleriniz için üretim yapılabilir.

* Her tip pako şalter için uygun kutu mevcuttur.

1 - 0 - 2 Kademeli / Kutup Değiştirici Pako Şalterler



Ürün Tanımı	Faz/Kutup Sayısı	Nominal Akım(A)	Sipariş Kodu	Birim Fiyat (€)
CSX-1P010A02M	1	10	500287	8,57
CSX-1P016A02M	1	16	500288	8,80
CSX-1P020A02M	1	20	500289	9,31
CSX-1P025A02M	1	25	500290	11,79
CSX-1P040A02M	1	32/40	500291	22,96
CSX-1P063A02TR	1	63	500292	24,82
CSX-1P080A02TR	1	80	500293	27,92
CSX-2P010A02M	2	10	500294	13,16
CSX-2P016A02M	2	16	500295	13,65
CSX-2P020A02M	2	20	500296	13,90
CSX-2P025A02M	2	25	500297	14,89
CSX-2P040A02M	2	32/40	500298	28,54
CSX-2P063A02TR	2	63	500299	31,27
CSX-2P080A02TR	2	80	500300	49,02
CSX-3P010A02M	3	10	500301	17,87
CSX-3P025A02M	3	25	500302	20,48
CSX-3P040A02M	3	32/40	500303	56,59
CSX-3P063A02TR	3	63	500304	59,56

* İstenildiği takdirde diğer Amper talepli kutup değiştiriciler de üretilebilir.

* İstenildiği takdirde " 1 - 2 " kademeli şalterlerde üretilebilir.

* Her tip pako şalter için uygun kutu mevcuttur.

CSX Serisi Kademeli Şalterler



Ürün Tanımı	Faz/Kutup Sayısı	Pozisyon	Nominal Akım(A)	Sipariş Kodu	Birim Fiyat (€)
CSX-1P010A032M	1	0-1-2	10	500414	10,23
CSX-1P016A032M	1	0-1-2	16	500415	10,55
CSX-1P020A032M	1	0-1-2	20	500416	11,17
CSX-1P025A032M	1	0-1-2	25	500417	12,41
CSX-1P040A032M	1	0-1-2	32/40	500418	23,73
CSX-1P063A032TR	1	0-1-2	63	500419	24,82
CSX-1P080A032TR	1	0-1-2	80	500420	28,54
CSX-1P010A033M	1	0-1-2-3	10	500421	11,74
CSX-1P016A033M	1	0-1-2-3	16	500422	12,29
CSX-1P020A033M	1	0-1-2-3	20	500423	13,65
CSX-1P025A033M	1	0-1-2-3	25	500424	14,89
CSX-1P040A033M	1	0-1-2-3	32/40	500425	33,51
CSX-1P063A033TR	1	0-1-2-3	63	500426	34,87
CSX-1P080A033TR	1	0-1-2-3	80	500427	40,33
CSX-1P010A034M	1	0-1-2-3-4	10	500428	16,13
CSX-1P016A034M	1	0-1-2-3-4	16	500429	17,38
CSX-1P020A034M	1	0-1-2-3-4	20	500430	22,34
CSX-1P025A034M	1	0-1-2-3-4	25	500431	24,82
CSX-1P040A034M	1	0-1-2-3-4	32/40	500432	40,95
CSX-1P063A034TR	1	0-1-2-3-4	63	500433	43,43
CSX-1P080A034TR	1	0-1-2-3-4	80	500434	50,63
CSX-1P010A035M	1	0-1-2-3-4-5	10	500435	16,31
CSX-1P016A035M	1	0-1-2-3-4-5	16	500436	17,75
CSX-1P020A035M	1	0-1-2-3-4-5	20	500437	18,00
CSX-1P025A035M	1	0-1-2-3-4-5	25	500438	21,10
CSX-1P040A035M	1	0-1-2-3-4-5	32/40	500439	51,50
CSX-1P063A035TR	1	0-1-2-3-4-5	63	500440	53,36
CSX-1P080A035TR	1	0-1-2-3-4-5	80	500441	62,05
CSX-1P010A037M	1	0-1-2-3-4-5-6-7	10	500449	23,70
CSX-1P016A037M	1	0-1-2-3-4-5-6-7	16	500450	23,95
CSX-1P020A037M	1	0-1-2-3-4-5-6-7	20	500451	24,20
CSX-1P025A037M	1	0-1-2-3-4-5-6-7	25	500452	26,06
CSX-1P040A037M	1	0-1-2-3-4-5-6-7	32/40	500453	71,97
CSX-1P063A037TR	1	0-1-2-3-4-5-6-7	63	500454	74,45
CSX-1P080A037TR	1	0-1-2-3-4-5-6-7	80	500455	86,86

CSX Serisi 7 Pozisyon Voltmetre Şalteri

Ürün Tanımı	Faz/Kutup Sayısı	Pozisyon	Nominal Akım(A)	Sipariş Kodu	Birim Fiyat (€)
CSX-3P010A07V	3	0-L1N-L2N-L3N-L1L2-L2L3-L1L3	10	500497	24,95
CSX-3P016A07V	3	0-L1N-L2N-L3N-L1L2-L2L3-L1L3	16	500498	25,44
CSX-3P020A07V	3	0-L1N-L2N-L3N-L1L2-L2L3-L1L3	20	500499	26,74

CHNT

Empower the World

Elektriğin kontrolü sizde!

Her durumda, maksimum koruma.

Chint, 36 yıllık deneyimiyle ürettiği otomatik sigortalar, kaçak akım koruma ürünleri ve parafudrlar ile evden fabrikaya tüm yapılarda güvenilir koruma sağlar.

3 Yıl
Garanti



Zengin yardımcı
aksesuar desteği



Teknik servis ve
destek hizmeti



Geniş ürün yelpazesi ile
eksiksiz ürün portföyü



Zorlu çevre
koşullarında sorunsuz
ve güvenilir çalışma



Montaj ve bakımı kolay
ergonomik tasarım



Otomatik Sigortalar

Kaçak Akım Röleleri

Parafudrlar



+90 216 621 00 55
www.chint.com.tr

CHINT

Empower the World

Sosyal Medya'da Bizi Takip Edin!

 @chintturkiye

 @Chintgroupturca

 @chintturkiye

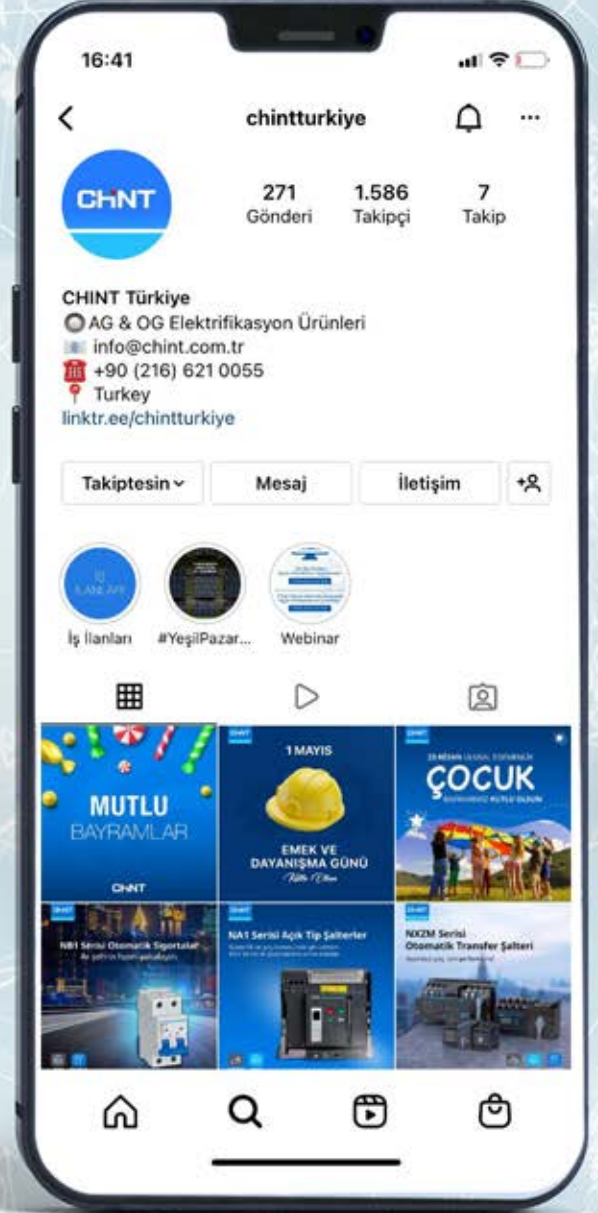

CHINT TURCA ELEKTRİK SANAYİ ve TİCARET A. Ş.

📍 Fatih Sultan Mehmet Mah. Poligon Cad. Buyaka 2 Sitesi, Kule-1, Kat:17, Ümraniye/İstanbul - Türkiye

☎ +90 216 621 00 55 / +90 216 621 00 50

✉ satis@chint.com.tr



Önemli Not: CHINT önceden haber verilmeksizin teknik değişiklikler yapma veya bu dokümanın içeriğini değiştirme hakkını saklı tutmaktadır. Satınalma operasyonlarında, üzerinde herhangi bir anlaşımın geçerli olmadığı, CHINT, bu dokümanla ilgili olarak herhangi bir sorumluluk kabul etmeyecektir. Bu doküman ve ilgili konularla ilgili kullanıcıların sorumlulukları belirlenmiştir. CHINT'in yazılımı kullanırken, her türlü kopyalama, çoğaltma, yayma veya diğer amaçlarla kullanılması yasaktır.